

GB Fitting Instructions for Basic Carrier

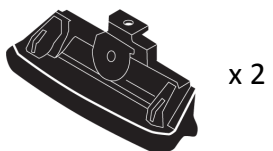

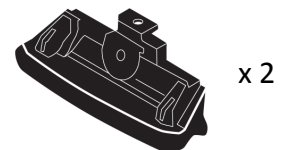

MAX kg

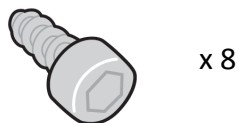
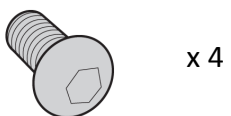
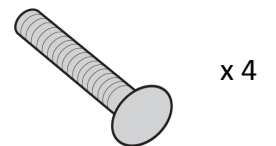
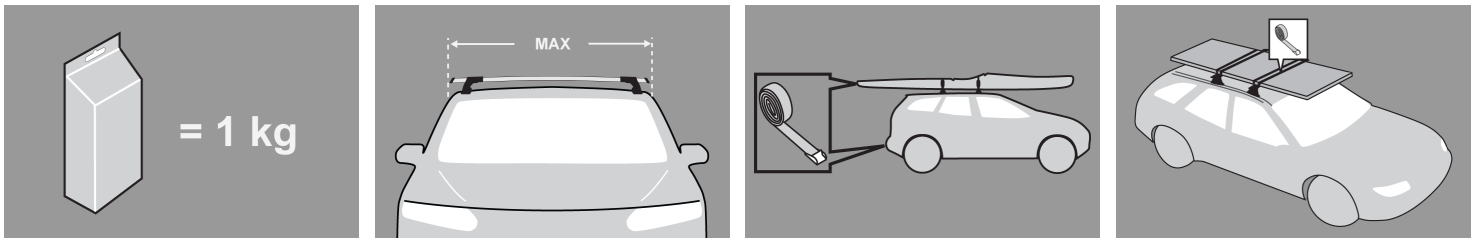
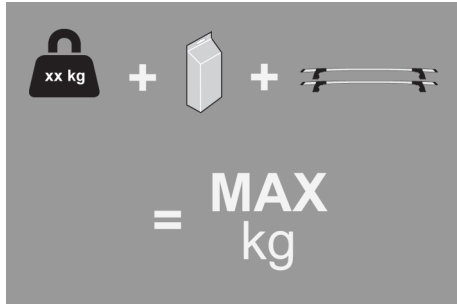

W/P WHD

MAX kg



W/P WHD

Audi

A3 Sportback, 5dr Hatch 04-+	EU	60	60	A3 Sportback, 5dr Hatch Mar 05-+	NZ	60	60
A3 Sportback, 5dr Hatch Mar 05-+	AU	60	60	A3 Sportsback, 5dr Hatch 06-+	US	60	60
A3 Sportshatch, 5dr Hatch 05-+	ZA	60	60	Q5, 5dr SUV 09-+	ZA	75	75
Q5, 5dr SUV 09-+	US	75	75	Q5, 5dr SUV 09-+	EU	75	75
Q5, 5dr SUV 09-+	NZ	75	75	Q5, 5dr SUV 09-+	AU	75	75

First Time Installation



- Remove parts from packaging and check contents. Contact your Prorack dealer if parts are missing or damaged.



- This kit fits type A, B, C and D.
- These instructions show type A crossbar fitted. They also apply to type B, C and D.



- Use keys to remove covers.



- Use hex screwdriver to reverse adjusting screw 10 turns.



- Press adjusting screw and pull crossbar legs out. Refer to the crossbar instructions for crossbar adjustment.
- Ensure each end of the crossbar is adjusted equally.

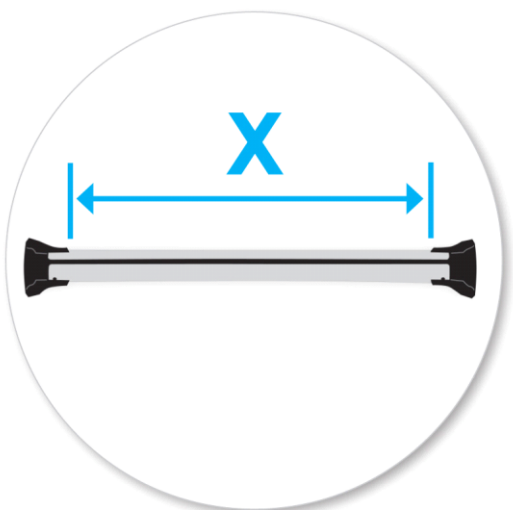

- Set bars to length (refer to the crossbar instructions for crossbar adjustment).
- Please check the rear of this manual for information relating specifically to your vehicle.



- Tighten adjusting screw to 5 Nm.



- Remove clamp block by pressing backwards.



- Remove both pins from each leg (use spanner located inside left hand cover to assist).



- Detach foot from leg. Store loose parts in a safe place.
- Repeat for all legs.



- Select four feet assemblies and match the left and right assemblies to the left and right roof rack legs.
- Assemble foot from kit into leg by pressing it down.
- Ensure foot interlocks with leg.

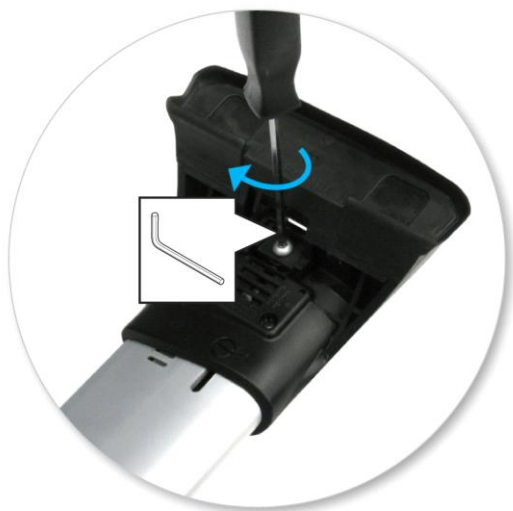

- Using short cap screw and washer, secure assembly onto leg (use Hex Screwdriver supplied with crossbar to assist)
- Do not over tighten.
- Repeat for all legs.



- Use two M5 x 12 mm self tapping screws to secure the assembly onto the leg.
- Do not over tighten.

Fitment



- Locate two holes at each position along the inside of the roof rails.
- Place crossbars approximately above these holes on roof rails.
- Ensure back edge of roof rack sits flush with the back edge of vehicle roof rail.

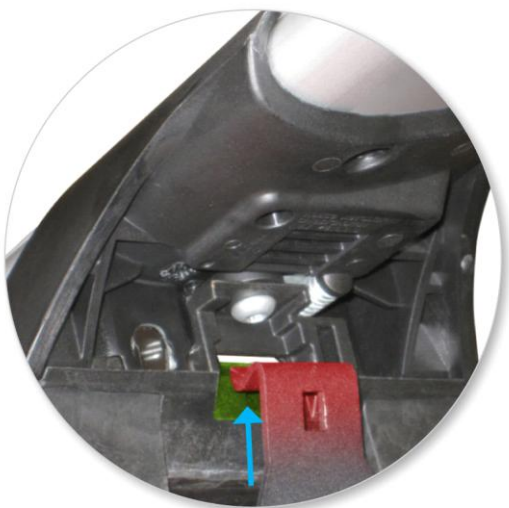

- NOTE: Use clamp 629A for Audi Q5 front left position.
- Ensure the two pins of the clamp engages correctly with the holes in the roof rail.
- Place one hand on the leg and apply downward pressure.
- Slide clamp through opening in leg.



- Thread the coach bolt through the clamp and the leg.



- Tighten the red plastic knob.
- Ensure the red plastic knob is in the position shown when fully tightened.
- Do not over tighten.
- Repeat for all four positions.
- Ensure the clamp engages correctly on inside of roof rail.



- Use keys to fit and lock covers
- Check crossbar is securely attached to the vehicle.

CAUTION:

Recheck all fasteners immediately after a load is applied to the crossbars.

Regularly check screws are tight.

Maintenance

- Clean the car roof and surfaces of the product that will be in contact with the car roof.
- Follow the fitting instructions for fitting the product to your vehicle. Make sure all steps are carried out in order.
- Set crossbars a minimum distance of 700mm apart where no other distance is specified in the fitting instructions. This is especially important when carrying long loads.
- Check unit is securely attached whenever you refit it to the vehicle. If the unit feels loose, refer to the fitting instructions and readjust.
- Some sunroofs and radio antennae cannot be used when the product is fitted.
- Do not modify this product.
- Refer to the maximum permitted load capacity specified in the fitting instructions. Do not exceed the vehicle manufacturers roof load rating if it is lower than the maximum load capacity specified in the fitting instructions.
- Loads should not overhang the sides of the product and be evenly distributed with the lowest possible centre of gravity.
- Long loads should be secured with non-elastic straps to the front and rear of the vehicle.
- Objects with pointed ends (skis) should be carried with the pointed ends to the rear of the vehicle.
- Remove all loose or removable objects from the load prior to loading.
- Make sure all loads are securely fastened with non-elastic straps. Check regularly during longer journeys.

- A loaded roof rack system can alter the performance of your vehicle. Be especially aware of the effects of side winds, changing of direction, and braking performance. Avoid rapid acceleration and deceleration. Drive carefully.
 - Note that the total height of the vehicle increases when upright loads are carried.
 - Products should be locked during transport if they have locks fitted.
 - Check and replace worn out or defective parts.
 - Keep the product clean and maintained.
 - Never drive into a car wash with the roof rack system fitted.
 - Lubricate locks and adjusting screws at regular intervals.
 - Remove the products from the vehicle when not in use. Make sure all loose parts are stored safely.
-

- Hubco Automotive Ltd
P. O. Box 11017
Christchurch
NEW ZEALAND

www.whispbar.com

A = -

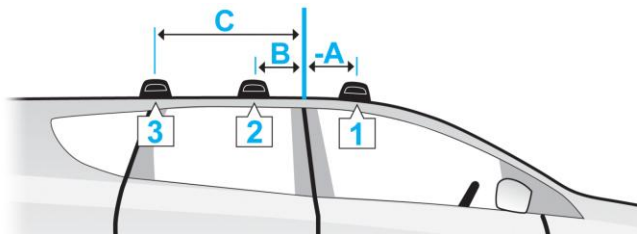

A = +

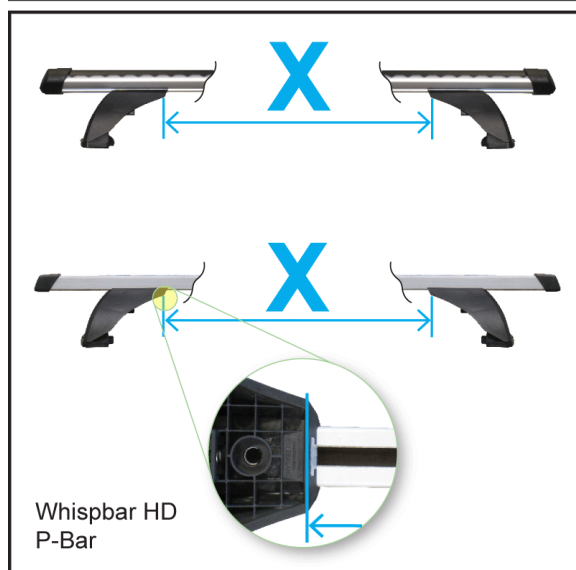
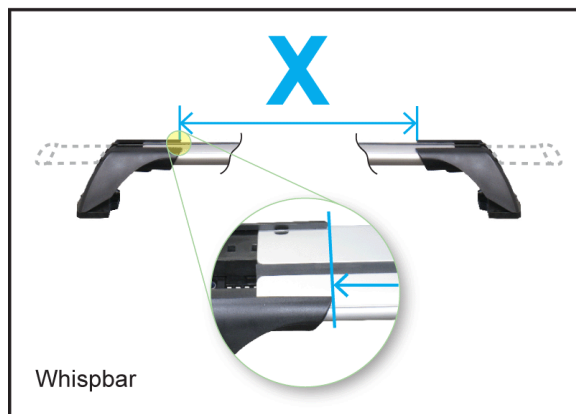
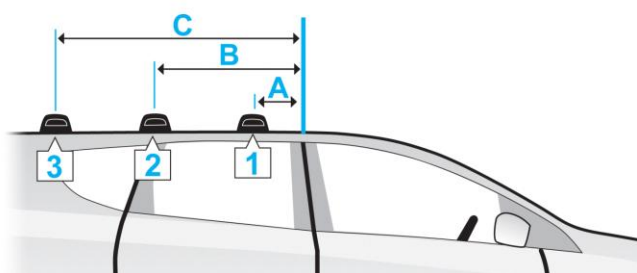

- Audi A3 Sportback, 5dr Hatch 04-+ (EU)
- Audi A3 Sportback, 5dr Hatch Mar 05-+ (AU)
- Audi A3 Sportback, 5dr Hatch Mar 05-+ (NZ)
- Audi A3 Sportsback, 5dr Hatch 06-+ (US)
- Audi A3 Sportshatch, 5dr Hatch 05-+ (ZA)
- Audi Q5 , 5dr SUV 09-+ (AU)
- Audi Q5 , 5dr SUV 09-+ (EU)
- Audi Q5 , 5dr SUV 09-+ (NZ)
- Audi Q5 , 5dr SUV 09-+ (US)
- Audi Q5 , 5dr SUV 09-+ (ZA)

	A	B	C	X		
				1	2	3
Audi A3 Sportback, 5dr Hatch 04-+ (EU)	-5cm -1 15/16ths"	69cm 27 3/16ths"	-	878mm 34 9/16ths"	829mm 32 5/8"	-
Audi A3 Sportback, 5dr Hatch Mar 05-+ (AU)	-5cm -1 15/16ths"	69cm 27 3/16ths"	-	878mm 34 9/16ths"	829mm 32 5/8"	-
Audi A3 Sportback, 5dr Hatch Mar 05-+ (NZ)	-5cm -1 15/16ths"	69cm 27 3/16ths"	-	878mm 34 9/16ths"	829mm 32 5/8"	-
Audi A3 Sportsback, 5dr Hatch 06-+ (US)	-5cm -1 15/16ths"	69cm 27 3/16ths"	-	878mm 34 9/16ths"	829mm 32 5/8"	-
Audi A3 Sportshatch, 5dr Hatch 05-+ (ZA)	-5cm -1 15/16ths"	69cm 27 3/16ths"	-	878mm 34 9/16ths"	829mm 32 5/8"	-
Audi Q5 , 5dr SUV 09-+ (AU)	-2cm - 13/16ths"	67cm 26 3/8"	-	928mm 36 9/16ths"	896mm 35 1/4"	-
Audi Q5 , 5dr SUV 09-+ (EU)	-2cm - 13/16ths"	67cm 26 3/8"	-	928mm 36 9/16ths"	896mm 35 1/4"	-
Audi Q5 , 5dr SUV 09-+ (NZ)	-2cm - 13/16ths"	67cm 26 3/8"	-	928mm 36 9/16ths"	896mm 35 1/4"	-
Audi Q5 , 5dr SUV 09-+ (US)	-2cm - 13/16ths"	67cm 26 3/8"	-	928mm 36 9/16ths"	896mm 35 1/4"	-
Audi Q5 , 5dr SUV 09-+ (ZA)	-2cm - 13/16ths"	67cm 26 3/8"	-	928mm 36 9/16ths"	896mm 35 1/4"	-