

# Kit 1043

**CHRYSLER Voyager**, 5-dr MPV, 96-00

**CHRYSLER Grand Voyager**, 5-dr MPV, 96-00

**CHRYSLER Town & Country**, 5-dr MPV, 96-00

**CHRYSLER Town & Country**, 5-dr MPV, 08- (NA)

**DODGE Grand Caravan**, 5-dr MPV, 08- (NA)

**VOLKSWAGEN Routan**, 5-dr MPV, 09- (NA)

480R  
754

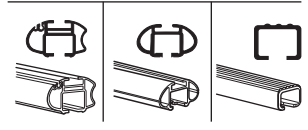
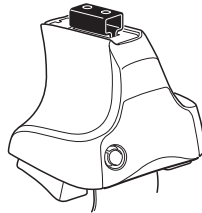

480

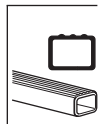
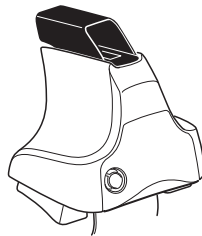

750

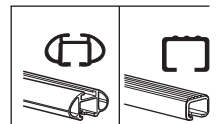
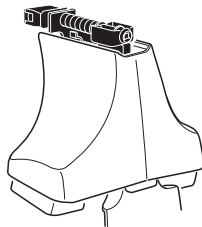

**THULE**<sup>®</sup>  
SWEDEN

CHRYSLER Voyager, 5-dr MPV, 96-00  
 CHRYSLER Grand Voyager, 5-dr MPV, 96-00  
 CHRYSLER Town & Country, 5-dr MPV, 96-00

**Max.**  
**50kg/110 lbs**



CHRYSLER Town & Country, 5-dr MPV, 08- (NA)  
 DODGE Grand Caravan, 5-dr MPV, 08- (NA)  
 VOLKSWAGEN Routan, 5-dr MPV, 09- (NA)

**Max.**  
**40 kg/88 lbs**

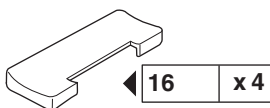
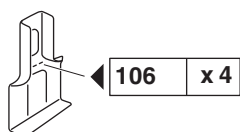
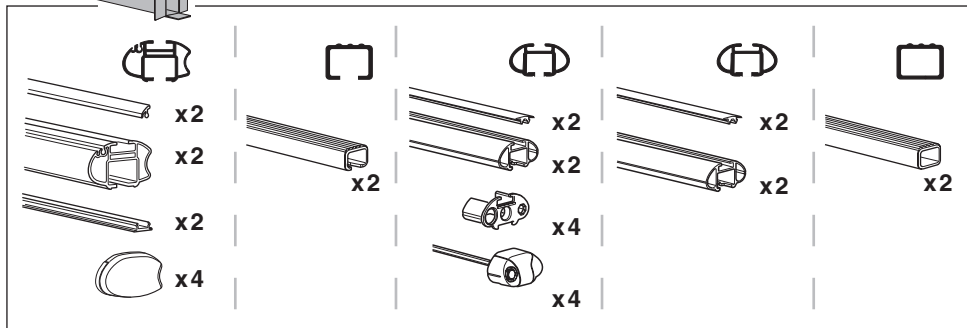
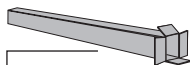
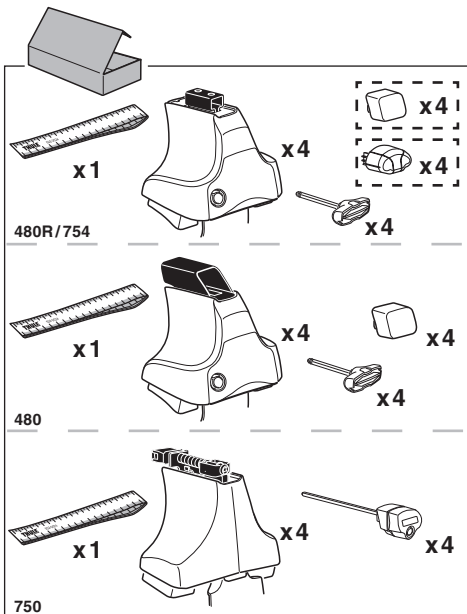
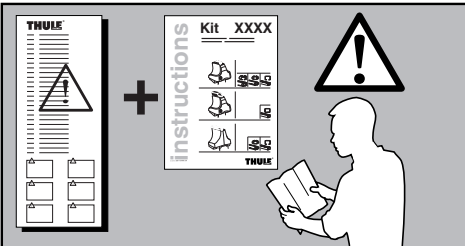
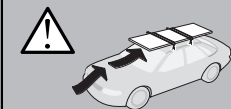

**Kit**

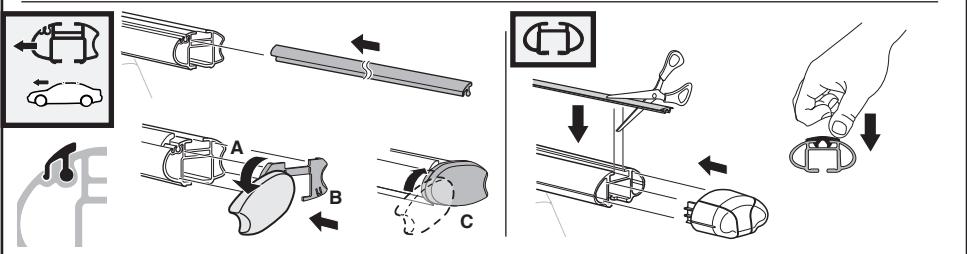

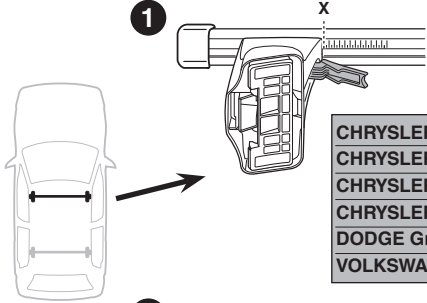
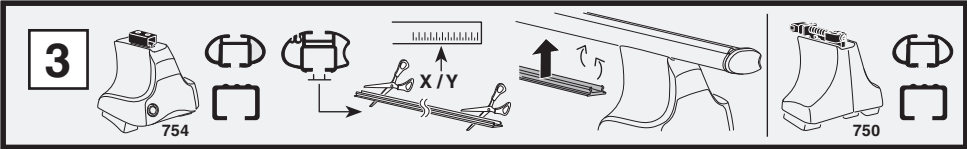

	X
<b>CHRYSLER Voyager, 5-dr MPV, 96-00</b>	<b>37</b>
<b>CHRYSLER Grand Voyager, 5-dr MPV, 96-00</b>	<b>37</b>
<b>CHRYSLER Town &amp; Country, 5-dr MPV, 96-00</b>	<b>37</b>
<b>CHRYSLER Town &amp; Country, 5-dr MPV, 08- (NA)</b>	<b>50</b>
<b>DODGE Grand Caravan, 5-dr MPV, 08- (NA)</b>	<b>50</b>
<b>VOLKSWAGEN Routan, 5-dr MPV, 09- (NA)</b>	<b>50</b>

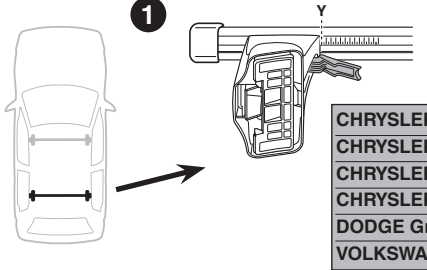
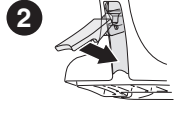

	Y
<b>CHRYSLER Voyager, 5-dr MPV, 96-00</b>	<b>37</b>
<b>CHRYSLER Grand Voyager, 5-dr MPV, 96-00</b>	<b>37</b>
<b>CHRYSLER Town &amp; Country, 5-dr MPV, 96-00</b>	<b>37</b>
<b>CHRYSLER Town &amp; Country, 5-dr MPV, 08- (NA)</b>	<b>50</b>
<b>DODGE Grand Caravan, 5-dr MPV, 08- (NA)</b>	<b>50</b>
<b>VOLKSWAGEN Routan, 5-dr MPV, 09- (NA)</b>	<b>50</b>

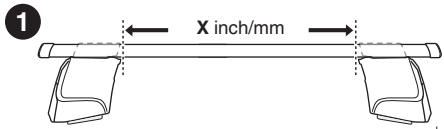
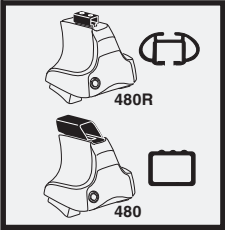

	X inch	X mm
<b>CHRYSLER Voyager, 5-dr MPV, 96-00</b>	<b>40 1/4"</b>	<b>1021 mm</b>
<b>CHRYSLER Grand Voyager, 5-dr MPV, 96-00</b>	<b>40 1/4"</b>	<b>1021 mm</b>
<b>CHRYSLER Town &amp; Country, 5-dr MPV, 96-00</b>	<b>40 1/4"</b>	<b>1021 mm</b>
<b>CHRYSLER Town &amp; Country, 5-dr MPV, 08- (NA)</b>	<b>45 3/8"</b>	<b>1151 mm</b>
<b>DODGE Grand Caravan, 5-dr MPV, 08- (NA)</b>	<b>45 3/8"</b>	<b>1151 mm</b>
<b>VOLKSWAGEN Routan, 5-dr MPV, 09- (NA)</b>	<b>45 3/8"</b>	<b>1151 mm</b>

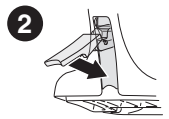
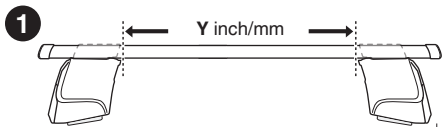
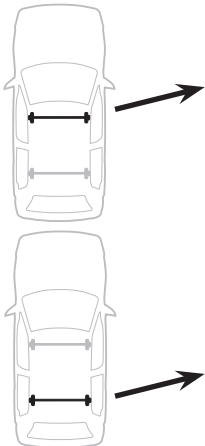

	Y inch	Y mm
<b>CHRYSLER Voyager, 5-dr MPV, 96-00</b>	<b>40 1/4"</b>	<b>1021 mm</b>
<b>CHRYSLER Grand Voyager, 5-dr MPV, 96-00</b>	<b>40 1/4"</b>	<b>1021 mm</b>
<b>CHRYSLER Town &amp; Country, 5-dr MPV, 96-00</b>	<b>40 1/4"</b>	<b>1021 mm</b>
<b>CHRYSLER Town &amp; Country, 5-dr MPV, 08- (NA)</b>	<b>45 3/8"</b>	<b>1151 mm</b>
<b>DODGE Grand Caravan, 5-dr MPV, 08- (NA)</b>	<b>45 3/8"</b>	<b>1151 mm</b>
<b>VOLKSWAGEN Routan, 5-dr MPV, 09- (NA)</b>	<b>45 3/8"</b>	<b>1151 mm</b>

# 4

CHRYSLER Voyager, 5-dr MPV, 96-00

CHRYSLER Grand Voyager, 5-dr MPV, 96-00

CHRYSLER Town & Country, 5-dr MPV, 96-00

CHRYSLER Town & Country, 5-dr MPV, 08- (NA)

DODGE Grand Caravan, 5-dr MPV, 08- (NA)

VOLKSWAGEN Routan, 5-dr MPV, 09- (NA)

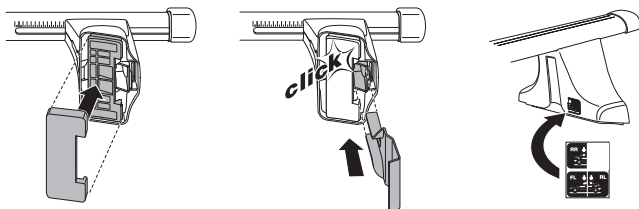
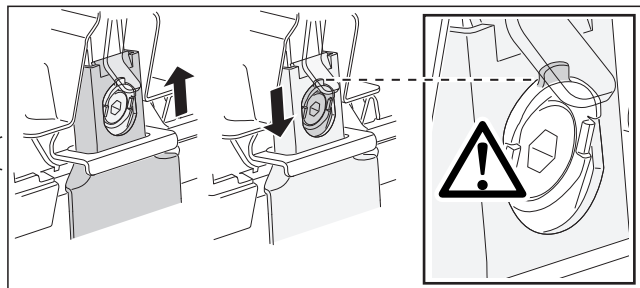
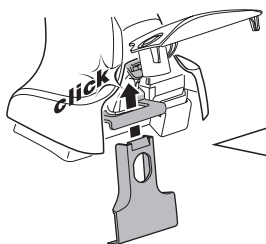
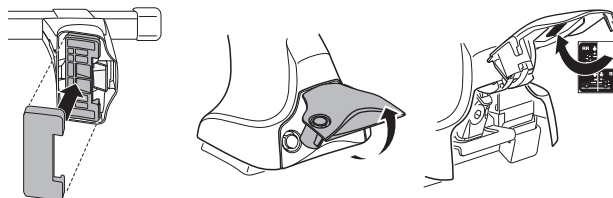
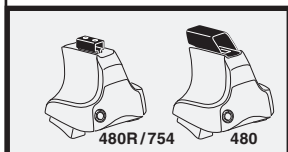
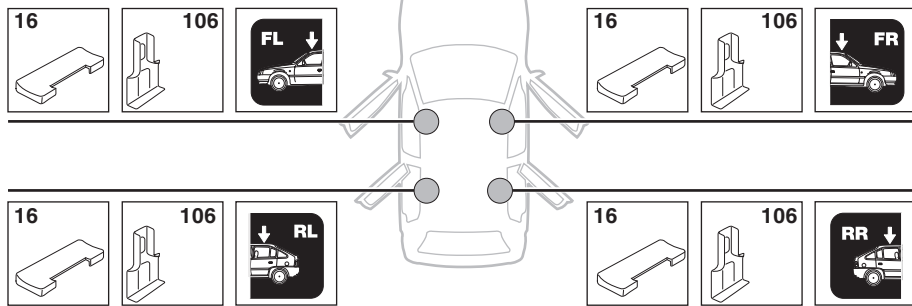

5

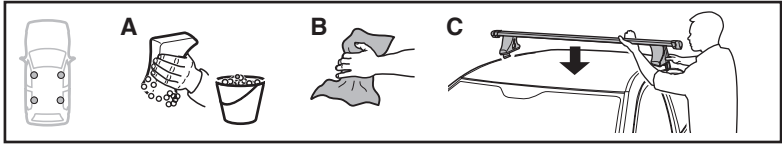

	X mm	Y mm	X inch	Y inch
<b>CHRYSLER Voyager</b> , 5-dr MPV, 96-00	630 mm	700 mm	24 <sup>3</sup> / <sub>4</sub> "	27 <sup>1</sup> / <sub>2</sub> "
<b>CHRYSLER Grand Voyager</b> , 5-dr MPV, 96-00	630 mm	700 mm	24 <sup>3</sup> / <sub>4</sub> "	27 <sup>1</sup> / <sub>2</sub> "
<b>CHRYSLER Town &amp; Country</b> , 5-dr MPV, 96-00	630 mm	700 mm	24 <sup>3</sup> / <sub>4</sub> "	27 <sup>1</sup> / <sub>2</sub> "
<b>CHRYSLER Town &amp; Country</b> , 5-dr MPV, 08- (NA)	700 mm	700 mm	27 <sup>1</sup> / <sub>2</sub> "	27 <sup>1</sup> / <sub>2</sub> "
<b>DODGE Grand Caravan</b> , 5-dr MPV, 08- (NA)	700 mm	700 mm	27 <sup>1</sup> / <sub>2</sub> "	27 <sup>1</sup> / <sub>2</sub> "
<b>VOLKSWAGEN Routan</b> , 5-dr MPV, 09- (NA)	700 mm	700 mm	27 <sup>1</sup> / <sub>2</sub> "	27 <sup>1</sup> / <sub>2</sub> "

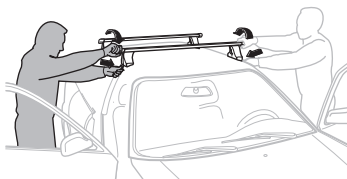
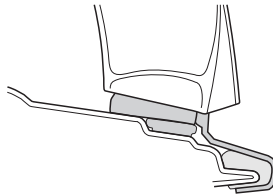
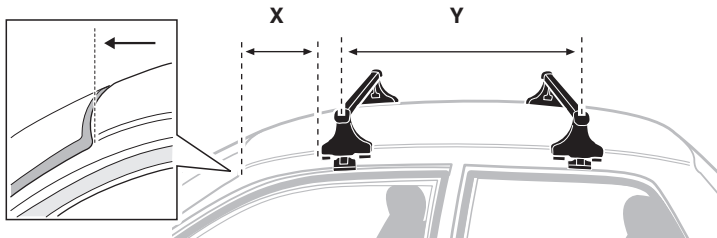

**GB/US** Tighten alternately

**D** Die Schrauben abwechselnd anziehen

**F** Serrer alternativement chaque côté

**NL** Afwisselend aan de linker- en de rechterkant aandraaien

**I** Alternare il serraggio delle viti

**E** Serrare alternativamente

**PT** Aperte alternadamente

**S** Dra åt växelvis

**FIN** Kierrä vuorotellen

**EST** Pinguldage vaheldumisi

**LAT** Pielvelciet pamišus

**LIT** Užsukinėkite pakaitomis

**PL** Śruby dokręcaj naprzemiennie

**RU** Затягивайте попеременно

**CZ** Pokręťta bagazníka dokręcaj dokręcaj naprzemiennie.

**SK** Doťahujte striedavo

**SLO** Privijajte izmenično.

**HR** Naizmjenično zategnite

**HU** Egymástól függetlenül szoritandó

**GR** Σφιγγετε εναλλάξ

**TR** Dönüşümlü sıkın

**中文** 交替拧紧

**한국어** 번갈아 가며 조이십시오.

**日本語** 交互に締め付けてください。

**ไทย** ชั้้นโน้แบบสลับ

6



480R/754



480

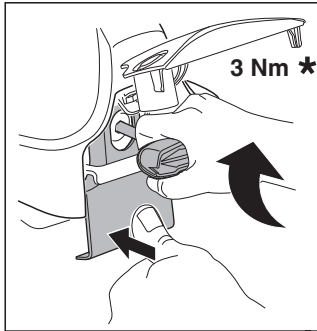
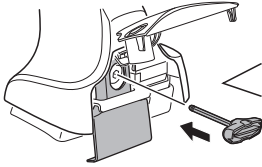

3 Nm \*

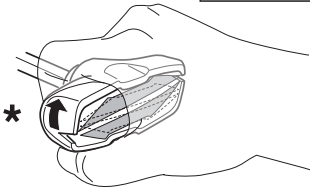
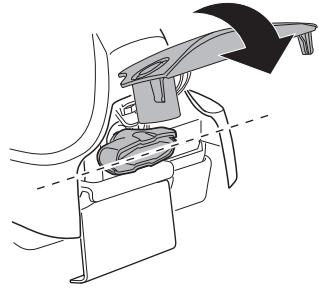

\*

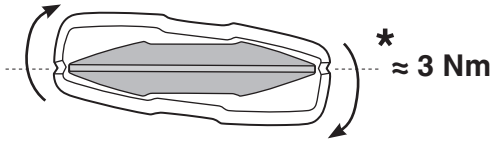

\* ≈ 3 Nm



750

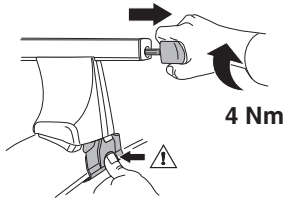

4 Nm

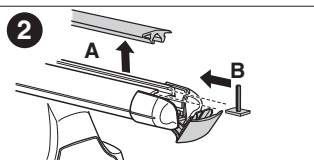
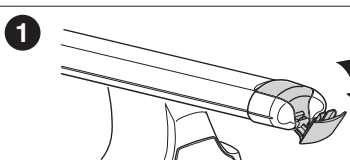
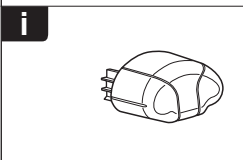
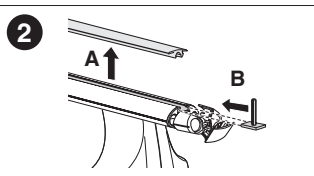
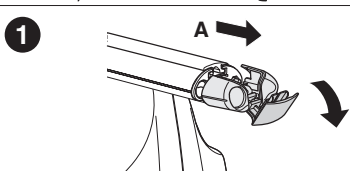
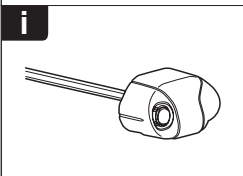
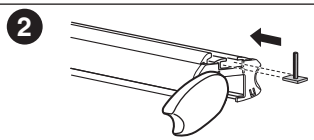
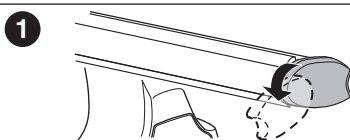
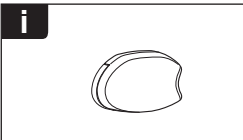
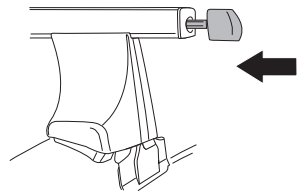

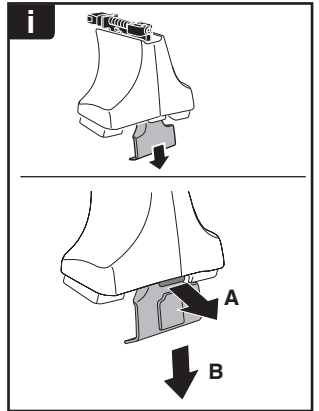

**THULE**  
SWEDEN  
**ONE  
KEY  
SYSTEM**



- 544 (x4)
- 596 (x6)
- 588 (x8)
- NA 510 (x10)
- EUR 452 (x12)
- ASIA



WW ▶ Thule Sweden AB, Box 69, 330 33 Hillerstorp, SWEDEN  
 NA ▶ Thule Inc., 42 Silvermine Road, Seymour, Connecticut 06483, USA

info@thule.com  
 customer.service@thule.com

www.thule.com