

Kit 1186

HYUNDAI Accent, 3-dr Hatchback, 00-02, 03-05

HYUNDAI Accent, 4-dr Sedan, 00-01, 02-05

HYUNDAI Accent, 5-dr Hatchback, 00-02, 03-05

HYUNDAI Verna, 3-dr Hatchback, 00-01, 02-05

HYUNDAI Verna, 4-dr Sedan, 00-01, 02-05

HYUNDAI Verna, 5-dr Hatchback, 00-01, 02-05

480R
754

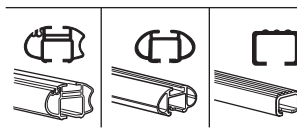
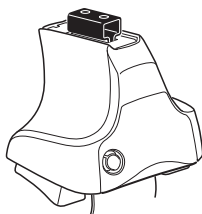

480

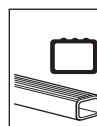
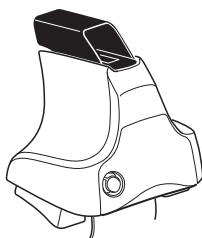

750

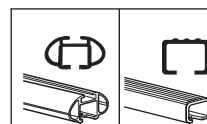
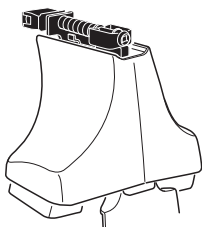

HYUNDAI Accent, 3-dr Hatchback, 00-02, 03-05
HYUNDAI Verna, 3-dr Hatchback, 00-01, 02-05

Max.
50kg/110 lbs

HYUNDAI Accent, 4-dr Sedan, 00-01, 02-05
HYUNDAI Accent, 5-dr Hatchback, 00-02, 03-05
HYUNDAI Verna, 4-dr Sedan, 00-01, 02-05
HYUNDAI Verna, 5-dr Hatchback, 00-01, 02-05

Max.
75 kg/165 lbs

Kit XXXX

- 1 Ruler
- 2 Screws
- 2 Screws
- 2 Screws
- 4 Caps
- 2 Bars
- 2 Bars
- 2 Bars
- 2 Bars
- 2 Bars
- 2 Bars
- 4 Screws
- 4 Screws

148 x 4

19 x 4

x 1

Kit

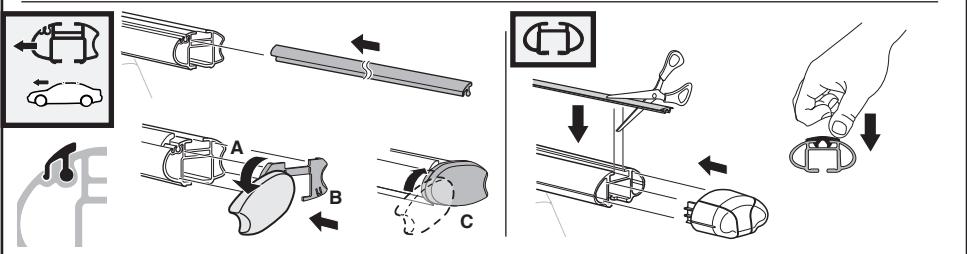

3

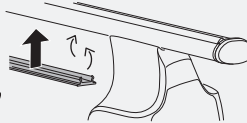
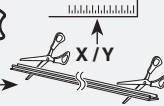

1

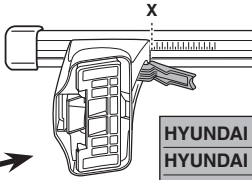

2



	X
HYUNDAI Accent, 3-dr Hatchback, 00-02, 03-05	29,5
HYUNDAI Accent, 4-dr Sedan, 00-01, 02-05	29,5
HYUNDAI Accent, 5-dr Hatchback, 00-02, 03-05	29,5
HYUNDAI Verna, 3-dr Hatchback, 00-01, 02-05	29,5
HYUNDAI Verna, 4-dr Sedan, 00-01, 02-05	29,5
HYUNDAI Verna, 5-dr Hatchback, 00-01, 02-05	29,5

1

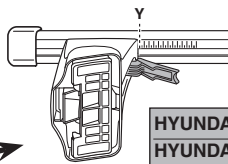

2

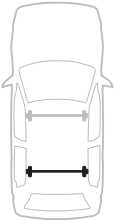
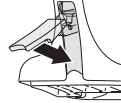

	Y
HYUNDAI Accent, 3-dr Hatchback, 00-02, 03-05	29,5
HYUNDAI Accent, 4-dr Sedan, 00-01, 02-05	30
HYUNDAI Accent, 5-dr Hatchback, 00-02, 03-05	30
HYUNDAI Verna, 3-dr Hatchback, 00-01, 02-05	29,5
HYUNDAI Verna, 4-dr Sedan, 00-01, 02-05	30
HYUNDAI Verna, 5-dr Hatchback, 00-01, 02-05	30



480R



480

1

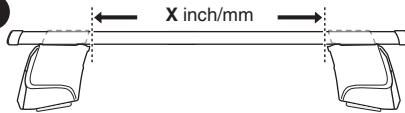

2

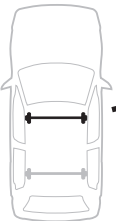
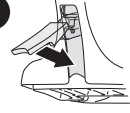

	X inch	X mm
HYUNDAI Accent, 3-dr Hatchback, 00-02, 03-05	37 1/4"	946 mm
HYUNDAI Accent, 4-dr Sedan, 00-01, 02-05	37 1/4"	946 mm
HYUNDAI Accent, 5-dr Hatchback, 00-02, 03-05	37 1/4"	946 mm
HYUNDAI Verna, 3-dr Hatchback, 00-01, 02-05	37 1/4"	946 mm
HYUNDAI Verna, 4-dr Sedan, 00-01, 02-05	37 1/4"	946 mm
HYUNDAI Verna, 5-dr Hatchback, 00-01, 02-05	37 1/4"	946 mm

1

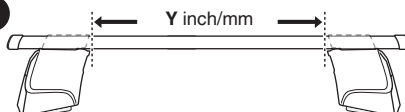

2



	Y inch	Y mm
HYUNDAI Accent, 3-dr Hatchback, 00-02, 03-05	37 1/4"	946 mm
HYUNDAI Accent, 4-dr Sedan, 00-01, 02-05	37 1/2"	951 mm
HYUNDAI Accent, 5-dr Hatchback, 00-02, 03-05	37 1/2"	951 mm
HYUNDAI Verna, 3-dr Hatchback, 00-01, 02-05	37 1/4"	946 mm
HYUNDAI Verna, 4-dr Sedan, 00-01, 02-05	37 1/2"	951 mm
HYUNDAI Verna, 5-dr Hatchback, 00-01, 02-05	37 1/2"	951 mm

4

HYUNDAI Accent, 3-dr Hatchback, 00-02, 03-05

HYUNDAI Verna, 3-dr Hatchback, 00-01, 02-05

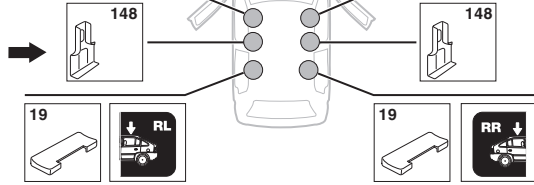
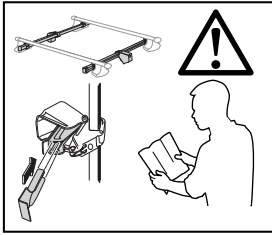
**SRA**

HYUNDAI Accent,
4-dr Sedan, 00-01, 02-05

HYUNDAI Accent,
5-dr Hatchback, 00-02, 03-05

HYUNDAI Verna,
4-dr Sedan, 00-01, 02-05

HYUNDAI Verna,
5-dr Hatchback, 00-01, 02-05

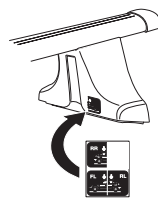
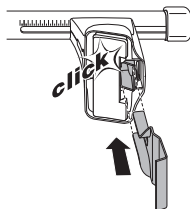
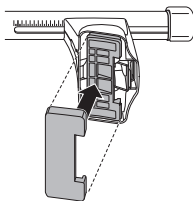
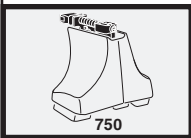
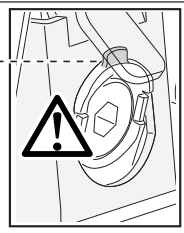
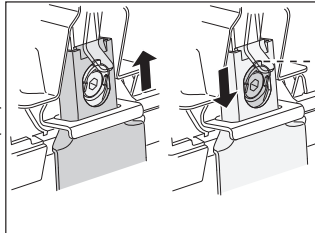
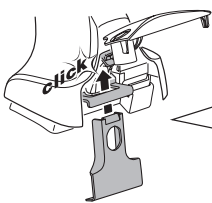
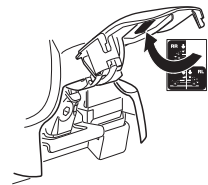
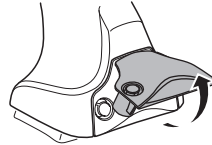
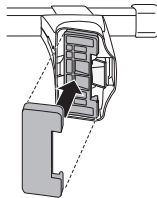
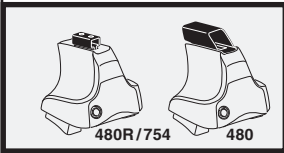

5

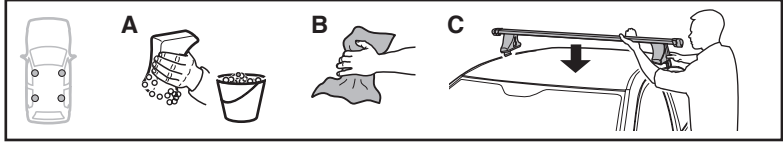

	X mm	Y mm	X inch	Y inch
HYUNDAI Accent , 3-dr Hatchback, 00-02, 03-05	230 mm	700 mm	9"	27 1/2"
HYUNDAI Accent , 4-dr Sedan, 00-01, 02-05	230 mm	670 mm	9"	26 3/8"
HYUNDAI Accent , 5-dr Hatchback, 00-02, 03-05	230 mm	670 mm	9"	26 3/8"
HYUNDAI Verna , 3-dr Hatchback, 00-01, 02-05	230 mm	700 mm	9"	27 1/2"
HYUNDAI Verna , 4-dr Sedan, 00-01, 02-05	230 mm	670 mm	9"	26 3/8"
HYUNDAI Verna , 5-dr Hatchback, 00-01, 02-05	230 mm	670 mm	9"	26 3/8"

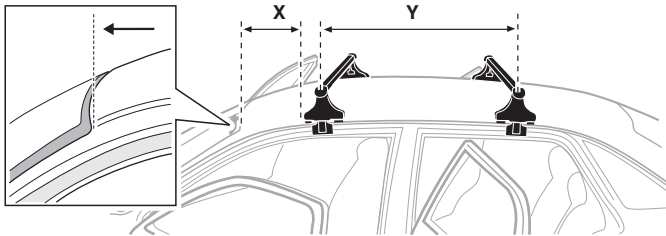

HYUNDAI Accent, 3-dr Hatchback, 00-02, 03-05

HYUNDAI Verna, 3-dr Hatchback, 00-01, 02-05

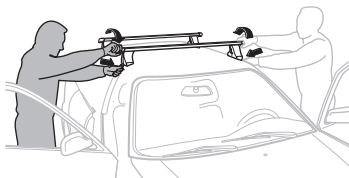
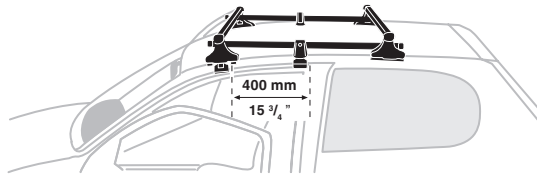

GB/US Tighten alternately

D Die Schrauben abwechselnd anziehen

F Serrer alternativement chaque côté

NL Afwisselend aan de linker- en de rechterkant aandraaien

I Alternare il serraggio delle viti

E Serrare alternativamente

PT Aperte alternadamente

S Dra åt växelvis

FIN Kierrä vuorotellen

EST Pinguldage vaheldumisi

LAT Pievelciēt pamīšus

LIT Užsukinėkite pakaitomis

PL Śruby dokręcaj naprzemiennie

RU Затягивайте попеременно

CZ Pokręťta bagażníka dokręcaj dokręcaj naprzemiennie.

SK Doťahujte striedavo

SLO Privijajte izmenično.

HR Naizmjenično zategnite

HU Egymástól függetlenül szorítandó

GR Σφιγγετε εναλλάξ

TR Dönüşümlü sıkın

中文 交替拧紧

한국어 번갈아 가며 조이십시오.

日本語 交互に締め付けてください。

ไทย ชั้้นในแบบสลับ

6



480R/754



480

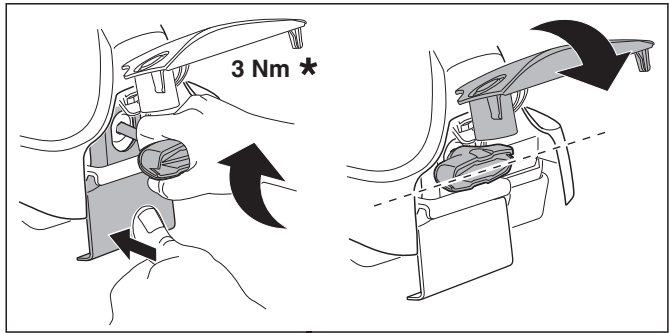
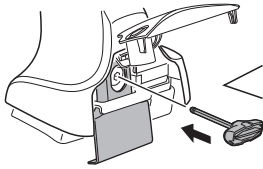

3 Nm *

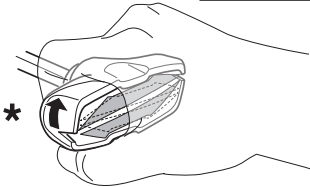

*

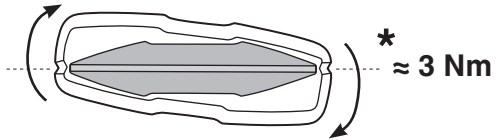

* ≈ 3 Nm



750

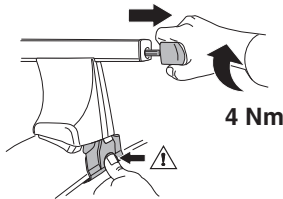

4 Nm

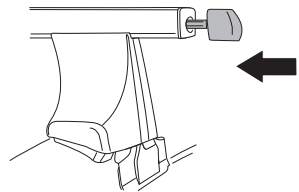

i



1



2

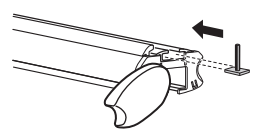

i

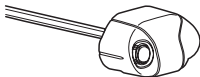

1

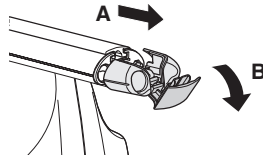

2

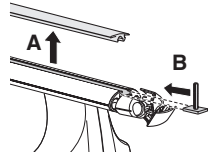

i



1

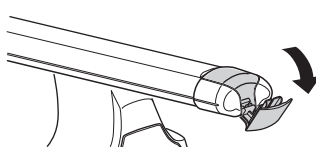

2

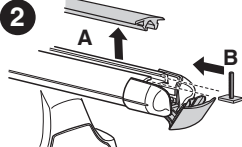

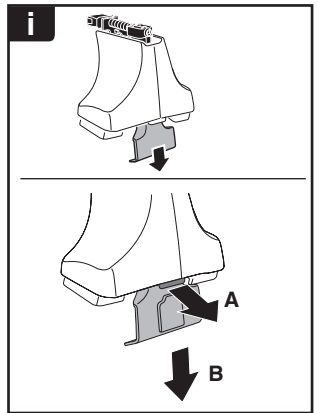
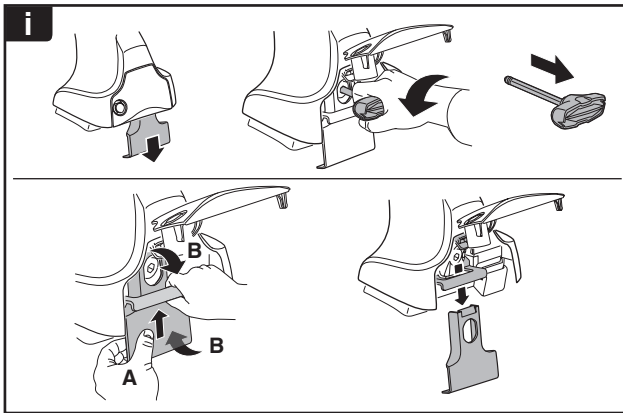
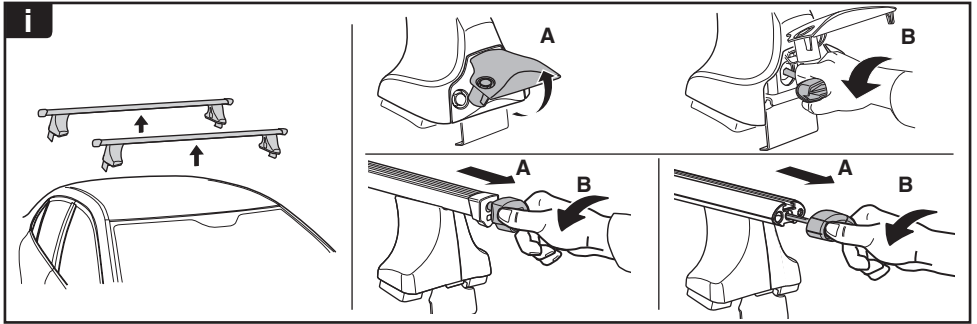

THULE
SWEDEN
**ONE
KEY
SYSTEM**



		(x4)
		(x6)
		(x8)
NA		(x10)
EUR		(x12)
ASIA		(x12)



WW ▶ Thule Sweden AB, Box 69, 330 33 Hillerstorp, SWEDEN
NA ▶ Thule Inc., 42 Silvermine Road, Seymour, Connecticut 06483, USA

info@thule.com
customer.service@thule.com

www.thule.com