

# Kit 1478

HYUNDAI I30 CW, 5-dr Estate, 08-\*

\* Without railing

480R  
754

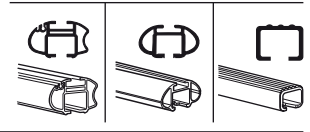
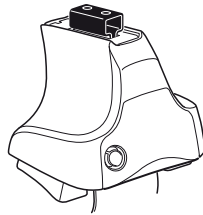

480

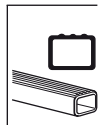
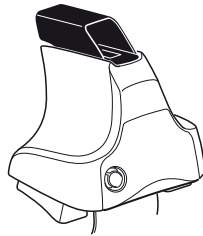

750

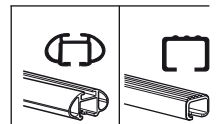
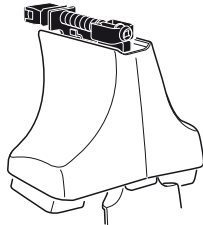

x2	x2	x2	x2	x2
x2		x2	x2	
x2		x4	x2	
x4		x4		

**958** x 4
 **65** x 4
 x 1

**Kit**

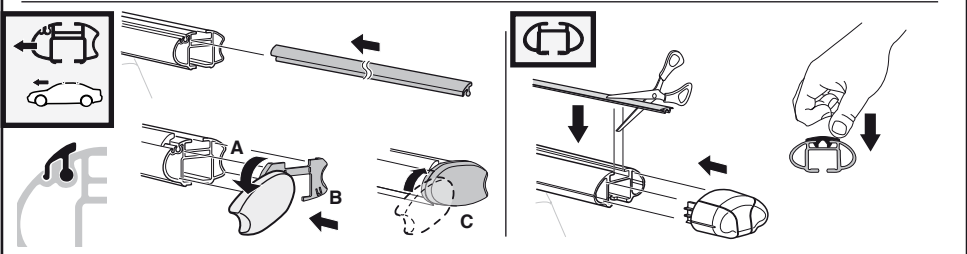
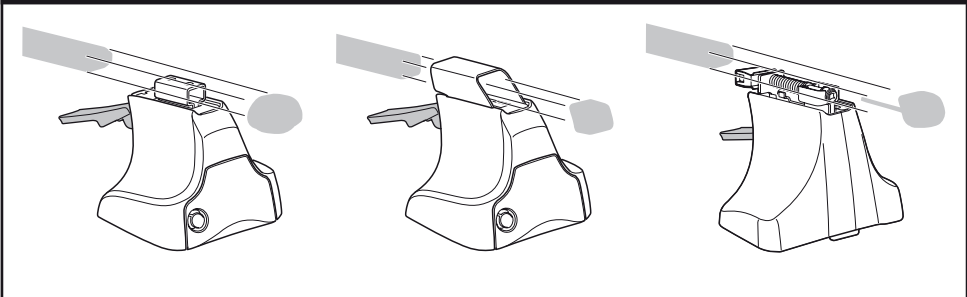

**3**



754

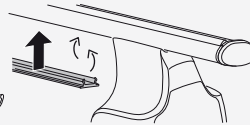
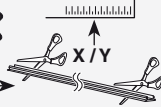

750



**1**

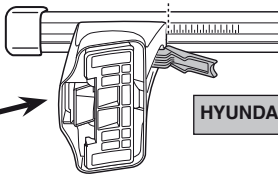
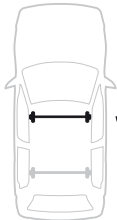

**2**

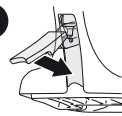

HYUNDAI I30 CW, 5-dr Estate, 08-

**X**  
32,5

**1**

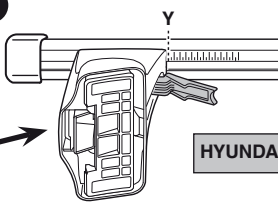

**2**

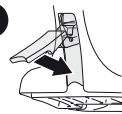

HYUNDAI I30 CW, 5-dr Estate, 08-

**Y**  
30,5



480R



480

**1**

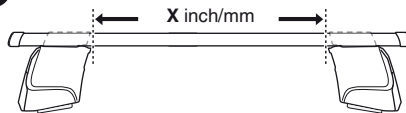

**2**



HYUNDAI I30 CW, 5-dr Estate, 08-

**X inch** | **X mm**  
38 <sup>3</sup>/<sub>8</sub>" | 976 mm

**1**

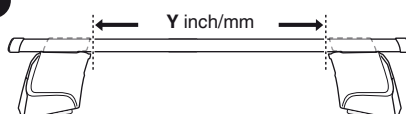

**2**



HYUNDAI I30 CW, 5-dr Estate, 08-

**Y inch** | **Y mm**  
37 <sup>5</sup>/<sub>8</sub>" | 956 mm

4

HYUNDAI I30 CW, 5-dr Estate, 08-

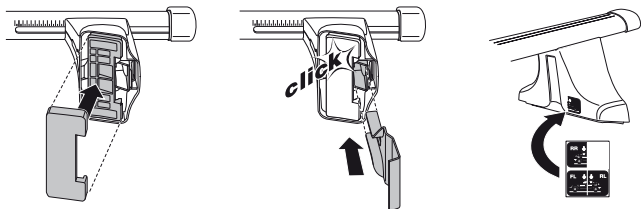
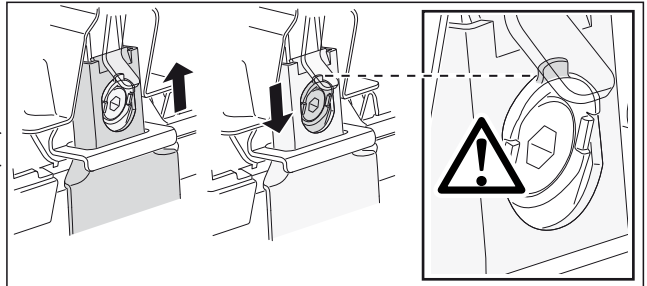
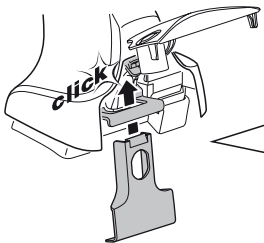
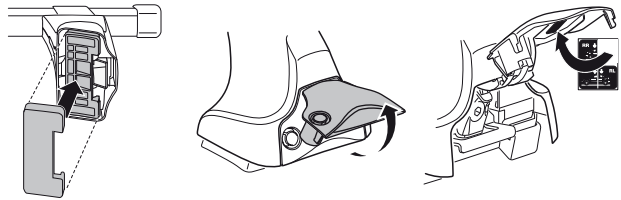
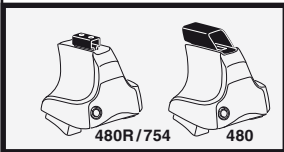
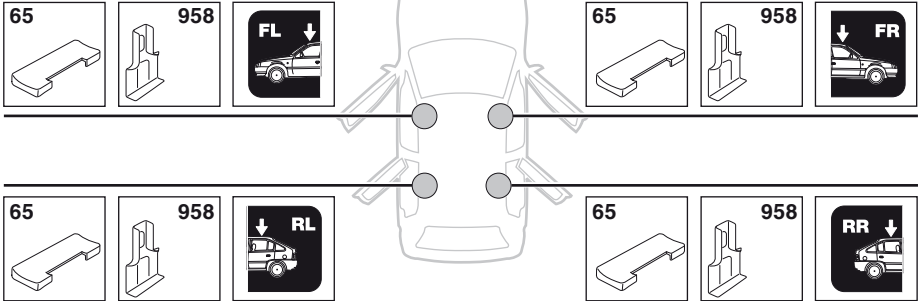

5

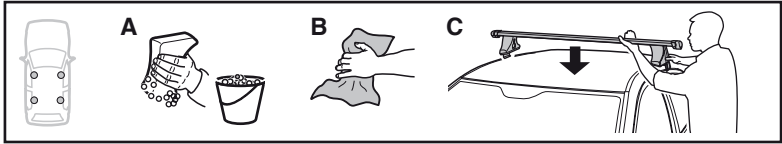

	X mm	Y mm	X inch	Y inch
HYUNDAI I30 CW, 5-dr Estate, 08-	450 mm	740 mm	17 <sup>3</sup> / <sub>4</sub> "	29 <sup>1</sup> / <sub>8</sub> "

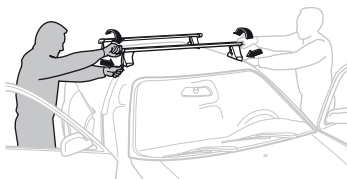
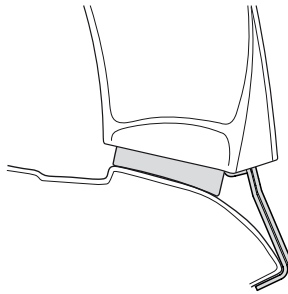
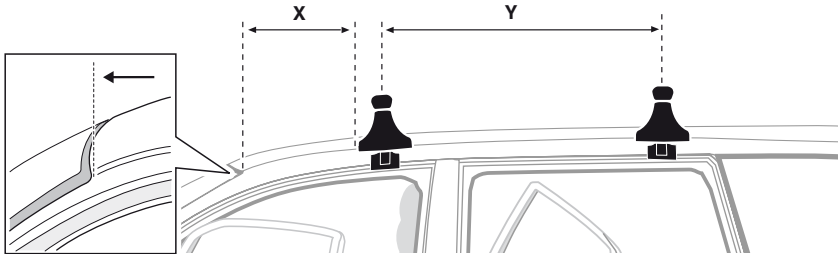

**GB/US** Tighten alternately

**D** Die Schrauben abwechselnd anziehen

**F** Serrer alternativement chaque côté

**NL** Afwisselend aan de linker- en de rechterkant aandraaien

**I** Alternare il serraggio delle viti

**E** Apertar alternativamente

**PT** Aperte alternadamente

**S** Dra åt växelvis

**FIN** Kierrä vuorotellen

**EST** Pinguldage vaheldumisi

**LAT** Pielvelciēt pamīšus

**LIT** Užsukinėkite pakaitomis

**PL** Śruby dokręcaj naprzemiennie

**RU** Затягивайте попеременно

**CZ** Pokręťta багаžníka dokręcaj dokręcaj naprzemiennie.

**SK** Doťahujte striedavo

**SLO** Privijajte izmenično.

**HR** Naizmjenično zategnite

**HU** Egymástól függetlenül szorítandó

**GR** Σφιγγετε εναλλάξ

**TR** Dönüşümlü sıkın

**中文** 交替拧紧

**한국어** 번갈아 가며 조이십시오.

**日本語** 交互に締め付けてください。

**ไทย** ชันโนแบบสลับ

6



480R/754



480

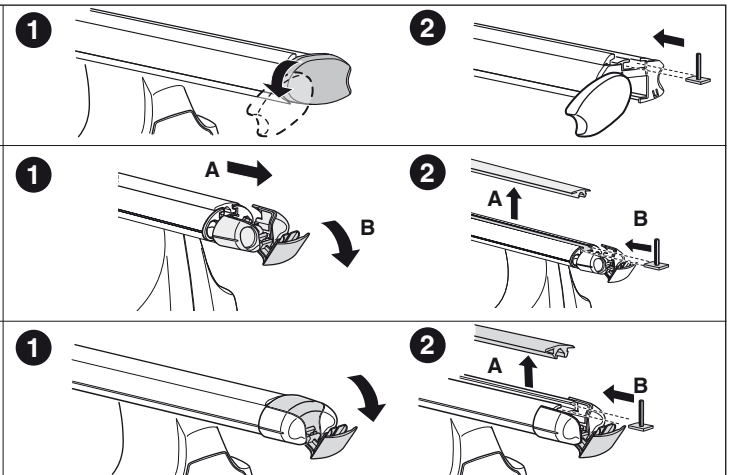
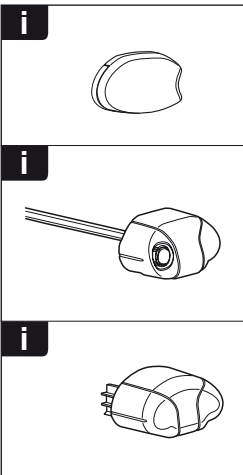
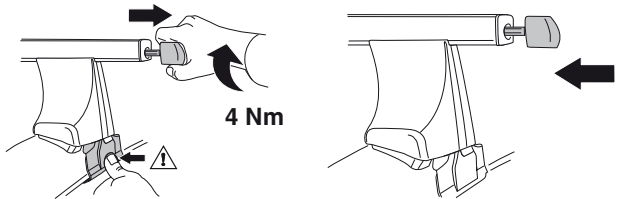
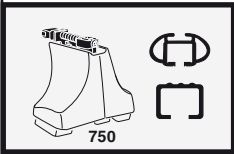
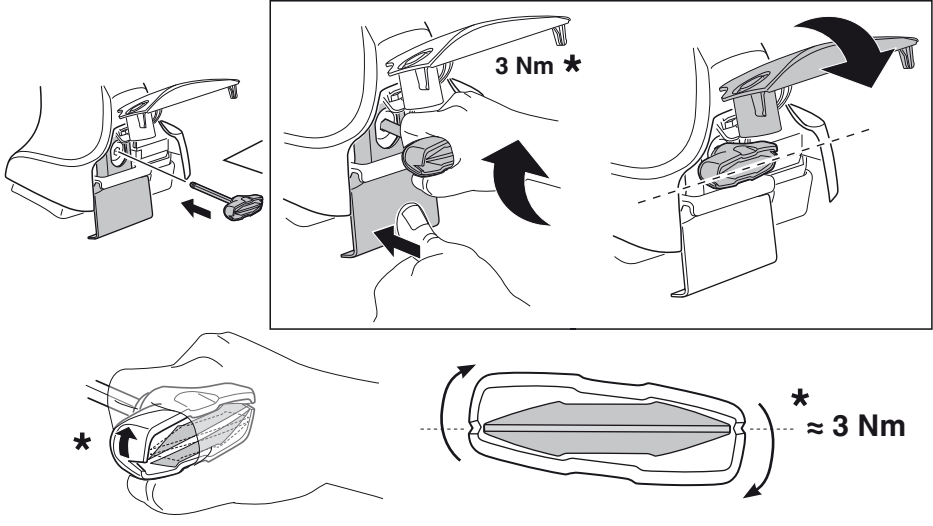

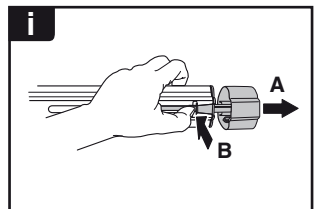
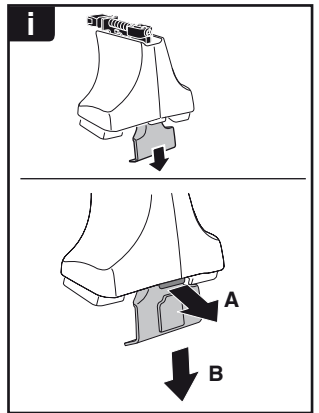
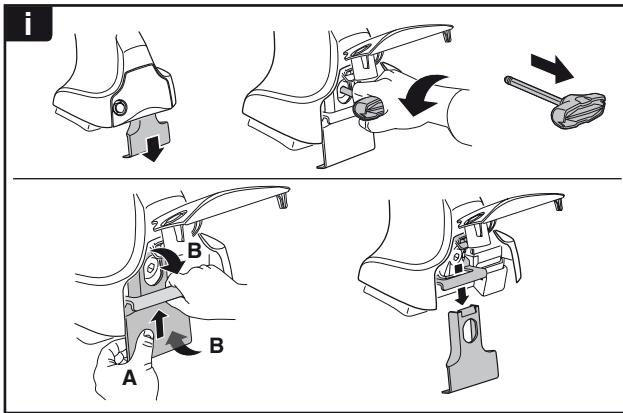
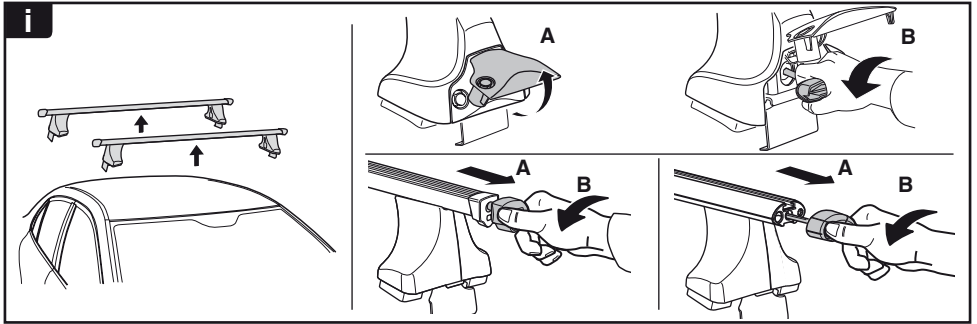

**THULE**  
SWEDEN  
**ONE  
KEY  
SYSTEM**



		(x4)
		(x6)
		(x8)
NA		(x10)
EUR		(x12)
ASIA		(x12)

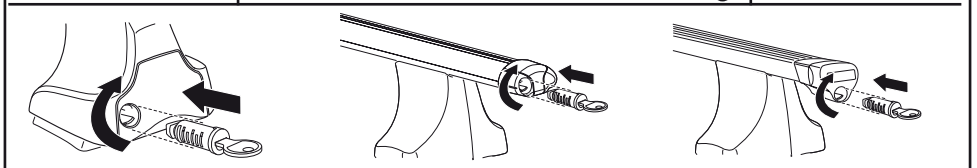

WW ▶ Thule Sweden AB, Box 69, 330 33 Hillerstorp, SWEDEN  
NA ▶ Thule Inc., 42 Silvermine Road, Seymour, Connecticut 06483, USA

info@thule.com  
customer.service@thule.com

www.thule.com