

Kit 1693

KIA Ceed, 5-dr Hatchback, 12- (With glassroof)

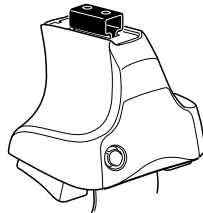

754 Rapid System
480R Rapid Traverse (North America)

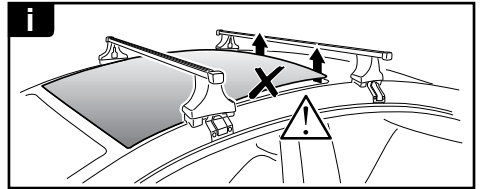
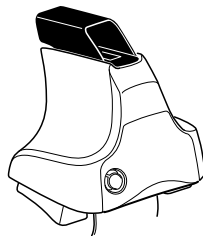
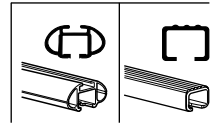

480 Traverse (North America)

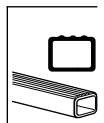

- 754 Rapid System: x1 (box), x4 (cubes), x4 (754 Rapid System), x4 (480R Rapid Traverse (North America)), x4 (screws)
- 480R Rapid Traverse (North America): x1 (ruler), x4 (480R Rapid Traverse (North America)), x4 (screws)
- 480 Traverse (North America): x1 (ruler), x4 (480 Traverse (North America)), x4 (screws)

- Bar: x2
- Hardware: x2 (23 mm), x2 (23 mm), x4 (screws), x4 (nuts)
- Hardware: x1 (17 mm), x2 (23 mm), x2 (23 mm), x4 (nuts)
- (North America): x2 (23 mm), x2 (23 mm), x2 (23 mm), x2 (bar), x2 (bar)

- Bracket: x2 (368)
- Bracket: x2 (798)
- Plate: x2 (07)
- Plate: x1 (249)
- Plate: x2 (250)
- Diagram: x1 (FR, FL, RL, RR)

1



2



754 Rapid System
480R Rapid Traverse
(North America)



x4

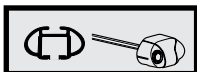

x4

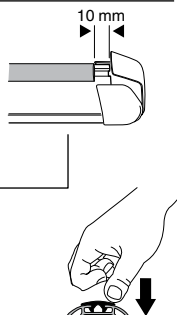
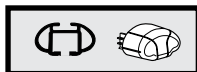

x4



480 Traverse
(North America)

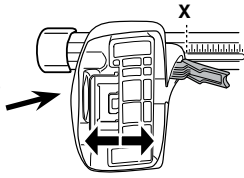

x4

3**754** Rapid System

	X
KIA Ceed, 5-dr Hatchback, 12- (With glassroof)	36,5

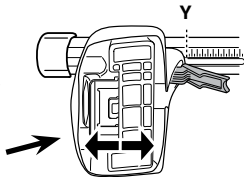

	Y
KIA Ceed, 5-dr Hatchback, 12- (With glassroof)	30

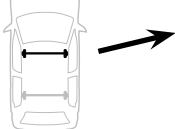
3**480R** Rapid Traverse**480** Traverse**(North America)**

	X inch	X mm
KIA Ceed, 5-dr Hatchback, 12- (With glassroof)	40"	1016 mm

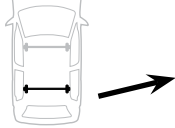

	Y inch	Y mm
KIA Ceed, 5-dr Hatchback, 12- (With glassroof)	37 1/2"	951 mm

4

5

KIA Ceed, 5-dr Hatchback, 12- (With glassroof)

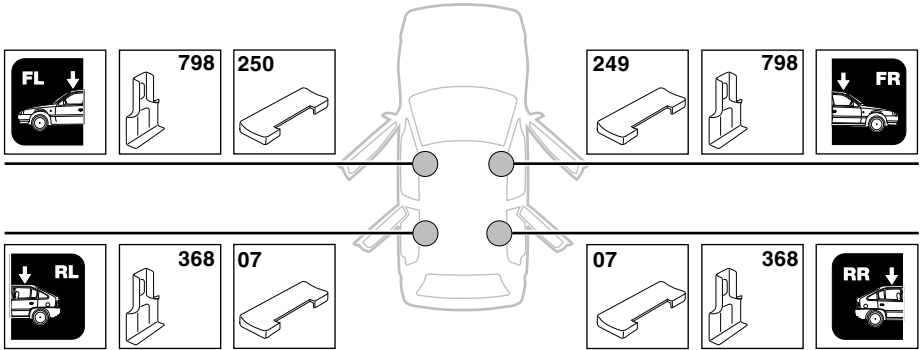

6

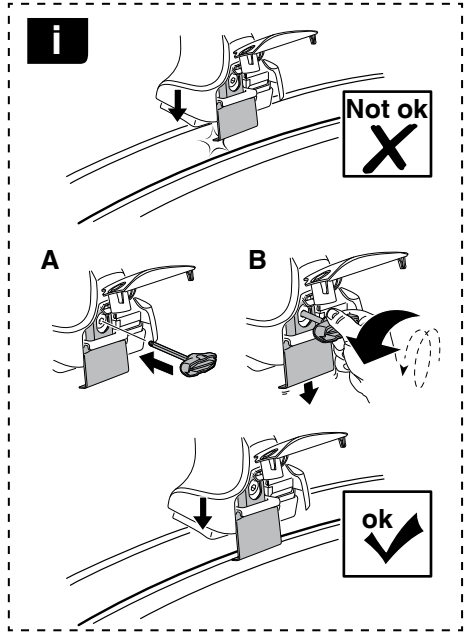
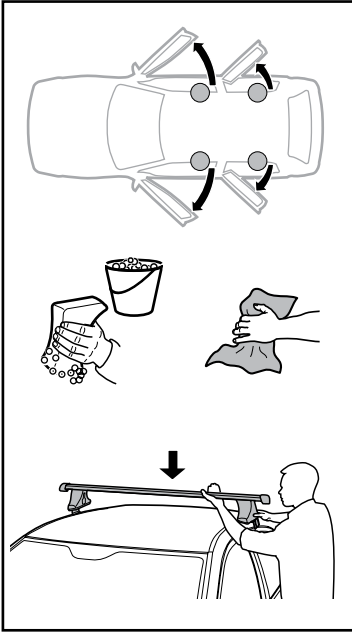

KIA Ceed, 5-dr Hatchback, 12- (With glassroof)

X mm

Y mm

X inch

Y inch

300 mm

700 mm

11 3/4"

27 1/2"

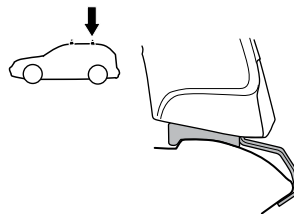
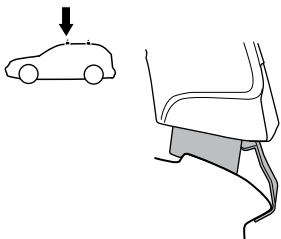
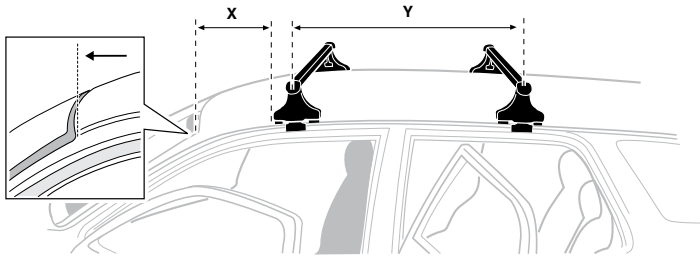

7

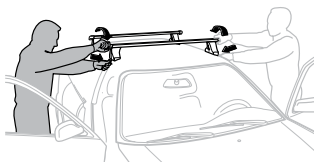

GB/US Tighten alternately
D Die Schrauben abwechselnd anziehen
F Serrer alternativement chaque côté
NL Afwisselend aan de linker- en de rechterkant aandraaien
I Alternare il serraggio delle viti
E Apertar alternativamente
PT Aperte alternadamente
S Dra åt växelvis
FIN Kierrä vuorotellen
EST Pinguldage vaheldumisi
LAT Pieļieciet pamišus
LIT Užsukinėkite pakaitomis
PL Śruby dokręcaj naprzemiennie
RU Затягивайте попеременно

CZ Pokręťta bagażnika dokręcaj naprzemiennie.
SK Dofahajte striedavo
SLO Privijajte izmenično.
HR Naizmjenično zategnite
HU Egymástól függetlenül szorítandó
GR Σφιγίγες εναλλάξ
TR Dönüşümlü sıkın

中文 交替拧紧

한국어 번갈아 가며 조이십시오.

日本語 交互に締め付けてください。

ไทย ชันในแบบสลับ

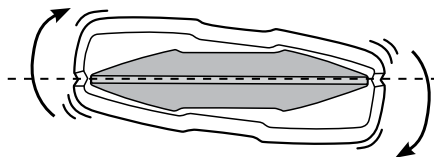
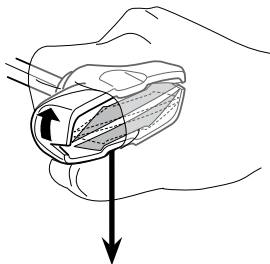
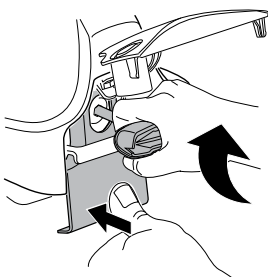
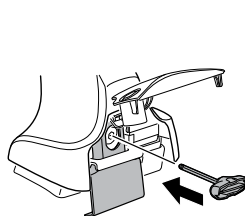

≈ 3 Nm

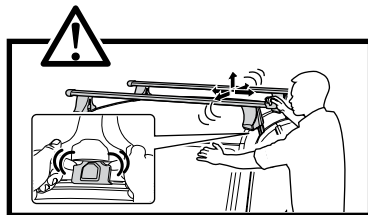
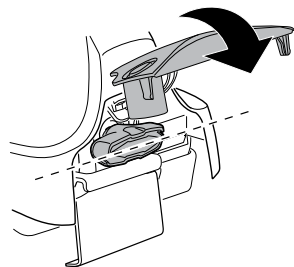

8

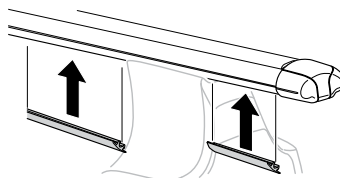
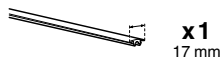



THULE
SWEDEN
**ONE
KEY
SYSTEM**



		(x4)
		(x6)
		(x8)
NA		(x10)
EUR		(x12)
ASIA		



WW ▶ Thule Sweden AB, Box 69, 330 33 Hillerstorp, SWEDEN
NA ▶ Thule Inc., 42 Silvermine Road, Seymour, Connecticut 06483, USA

info@thule.com
customer.service@thule.com

www.thule.com