

Kit 3015

FORD Focus C-Max, 5-dr Hatchback, 03-10

FORD Focus II, 3-dr Hatchback, 05-07, 08-10

FORD Focus II, 5-dr Hatchback, 05-07, 08-10

FORD Focus II, 4-dr Sedan, 05-07, 08-10

FORD Focus II, 5-dr Estate, 05-07, 08-10

This Kit is only for vehicles with fixpoint mounting.

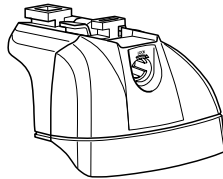

460R
753

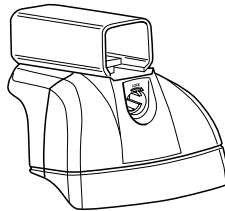
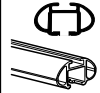

460

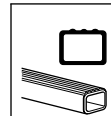

THULE[®]
SWEDEN

ISO 11154-E

Kit

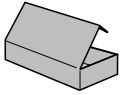

753

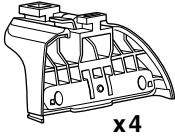

x4



x4



x4



x8

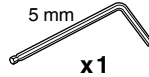

x1



x4



x1

460R

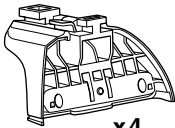

x4



x4



x4



x8

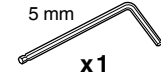

x1



x4

460

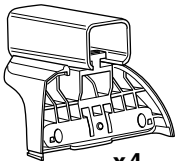

x4



x4



x4



x8

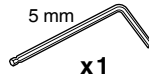

x1



x4

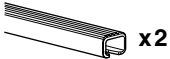
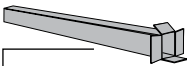

x2



x2

17 mm

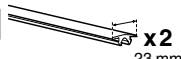

x2

23 mm

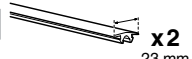

x2

23 mm

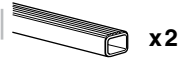

x2

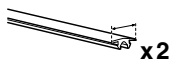

x2

23 mm

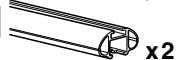

x2

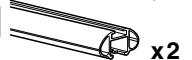

x2

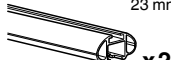

x2



x4



x4



x4

1

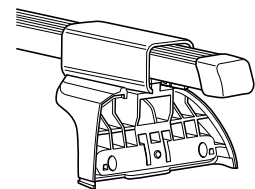
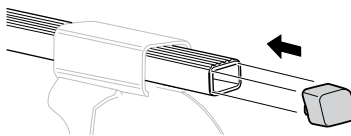
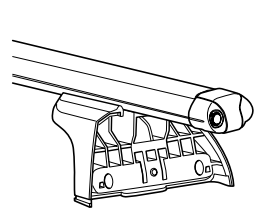
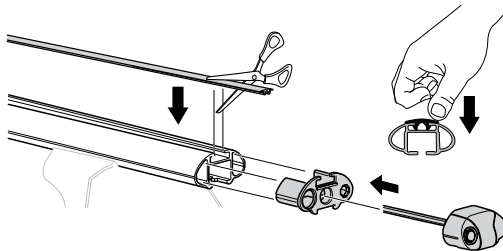
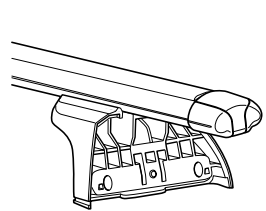
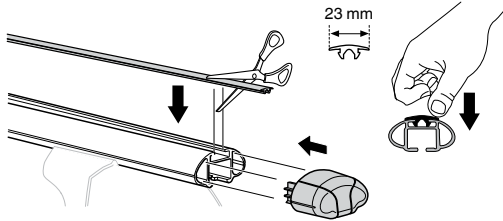
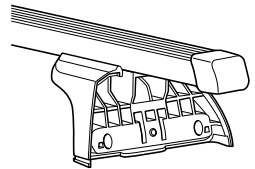
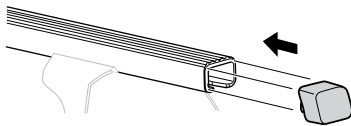
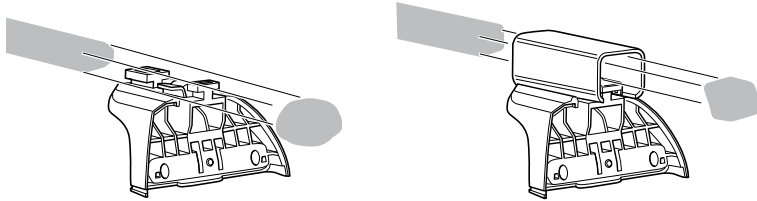
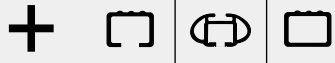
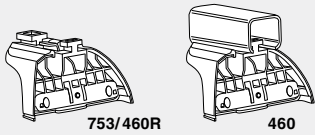

2

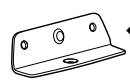

01 x 4

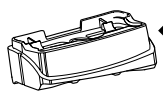

16 x 2



17 x 2

16 mm  x 8

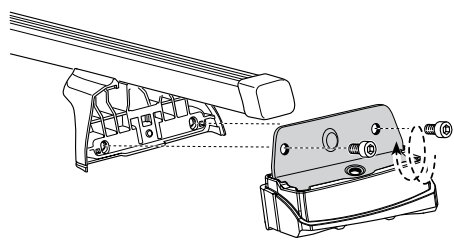
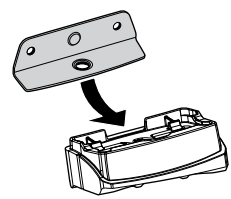
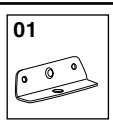
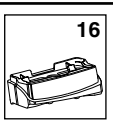
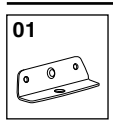
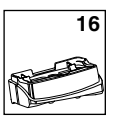
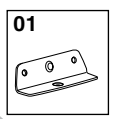
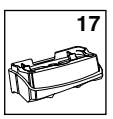
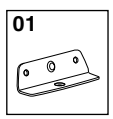
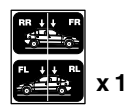

i

i

GB Only a few turns
D Nur wenige Umdrehungen
F Quelques tours uniquement
NL Slechts enkele slagen
I Solo qualche giro
E Sólo algunas vueltas
PT Noções básicas
S Endast några varv
FIN Vain muutama kierros

EST Ainult mõni pööre
LAT Tikai dažī apgriezieni
LIT Tik keli pasukimai
PL Wystarczy kilka obrotów
RU Достаточно нескольких оборотов
CZ Pouze několik otáček
SK Len niekoľko otáčok
SLO Le nekaj obratov

HR Samo nekoliko okreta
HU Csak néhány fordítás
GR Μόνο μερικές στροφές
TR Yalnız birkaç kez çevirm
中文 只有几个转向
한국어 두 세번만
日本語 数回転のみ
ไทย หมุนเพียงไม่กี่รอบ

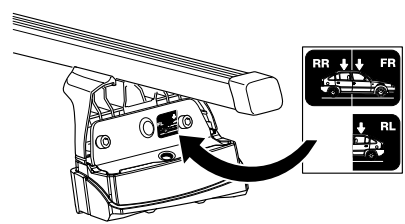

3

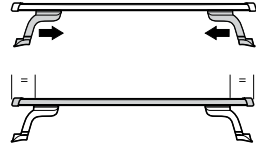
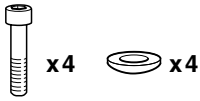

A

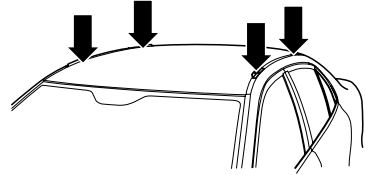
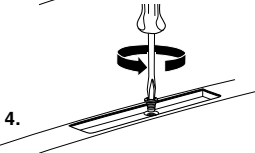
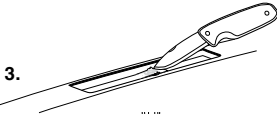
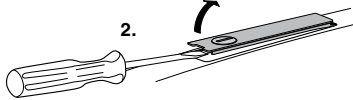
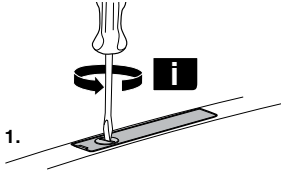

B

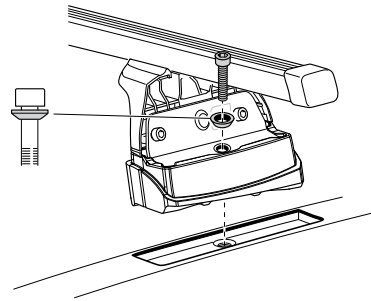

C

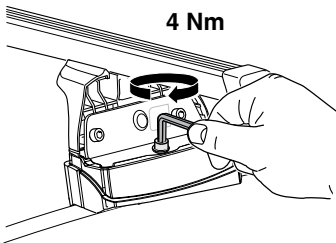

D

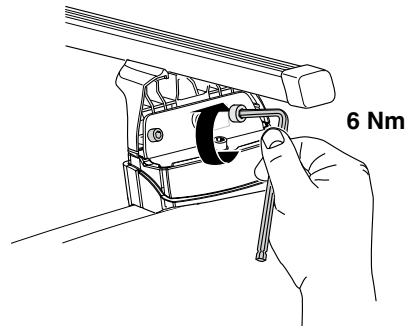

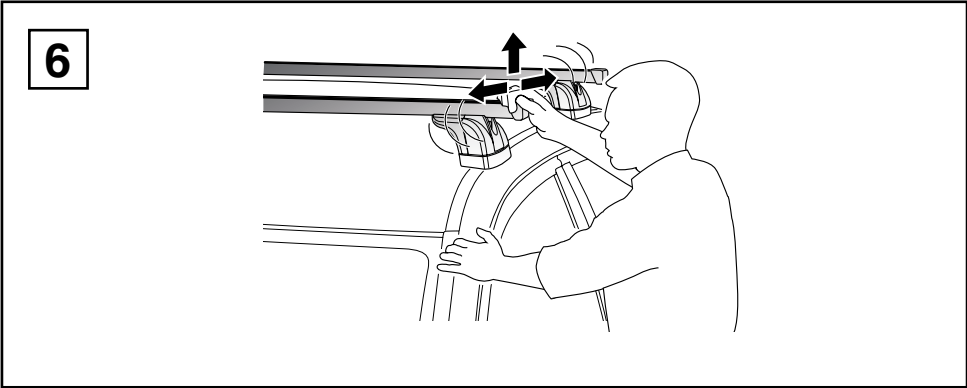
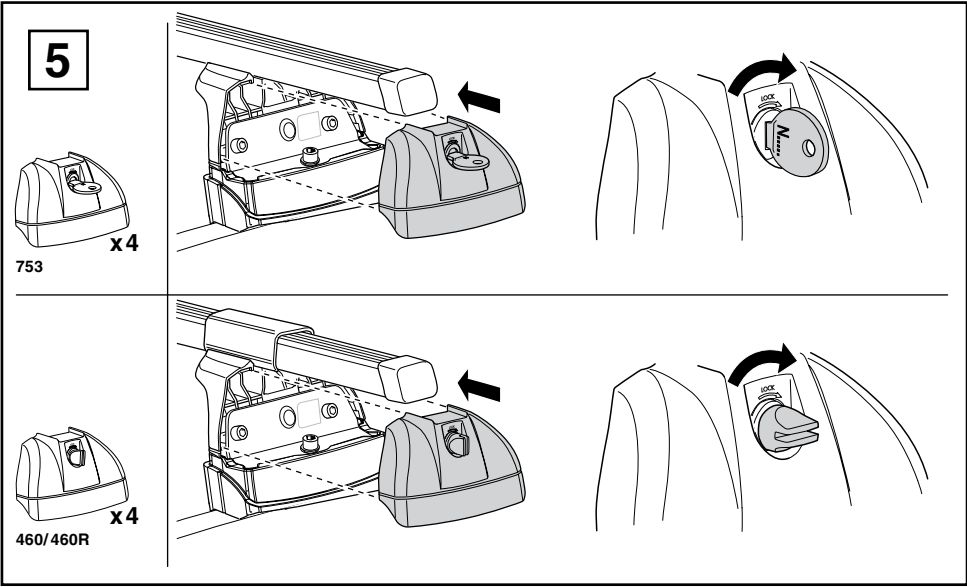
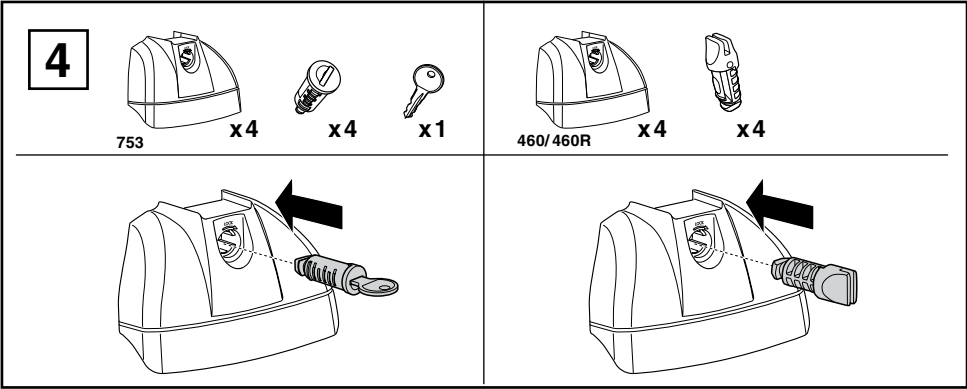

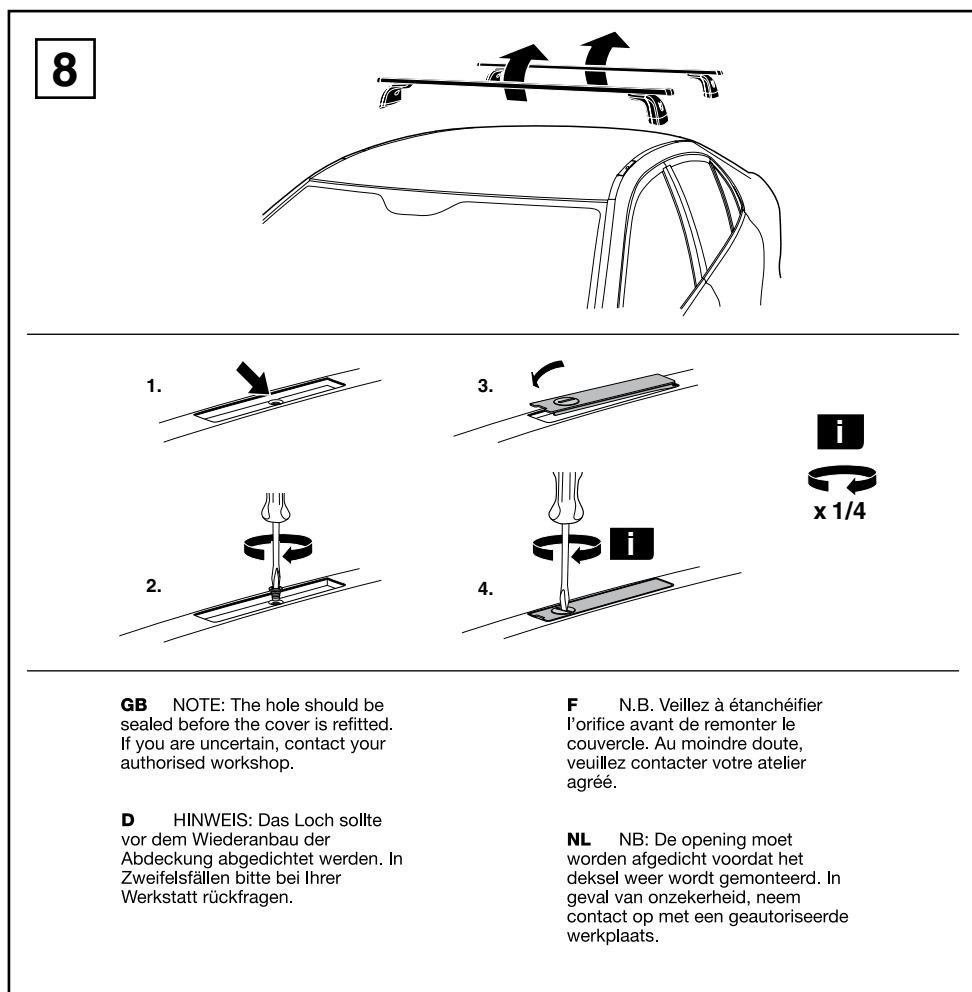
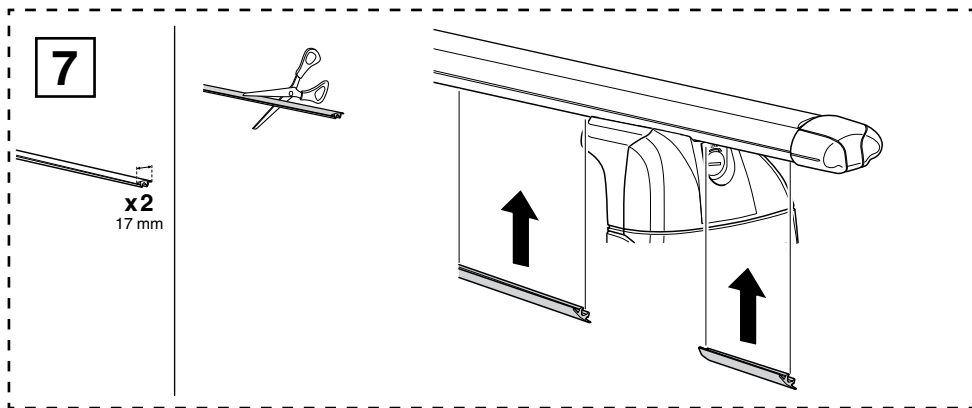

I Nota: Il foro andrebbe sigillato prima di rimettere il coperchio. Se avete dubbi, chiedete alla vostra officina autorizzata.

E NOTA: el agujero debe obturarse antes de volver a montar la tapa. En caso de dudas, póngase en contacto con nuestro taller autorizado.

PT NOTA: O orifício deve ser lacrado antes da cobertura ser montada novamente. Caso esteja inseguro, contate sua oficina autorizada.

S OBSERVERA: hålet bör tätas innan locket återmonteras. Vid osäkerhet kontakta din auktoriserade verkstad.

FIN HUOMAA: Reikä pitää peittää ennen kuin kansi sovitaan paikalleen. Jos olet epävarma, ota yhteyttä valtuutettuun korjaamoosi.

EST MÄRKUS: enne katte tagasipanekut tuleb ava sulgeda. Kui Teil on kahtlusi, pöörduge volitatud töökotta.

LAT PIEZĪME: pirms uzliet vāciņu atpakad, noblīvējiet caurumu. Neskaidrību gadījumā sazinieties ar pilnvarotu darbnīcu.

LIT PASTABA: Prieš vėl uždedant dangtelį, angį reikia užsandarinti. Jei nežinote, kaip tai padaryti, kreipkitės á ágalioťsias dirbtuves.

PL Uwaga: Przed załozeniem pokrywy nalezy zaslepic gwintowany otwór. W razie wątpliwości skontaktuj się z lokalnym sprzedawcą Thule.

RU ВНИМАНИЕ: Отверстие должно быть закрыто до установки крышки на место. В случае сомнения обращайтесь в авторизованную мастерскую.

CZ POZNÁMKA: Než vrátíte krytku na své místo, měl by být otvor utěsněn. Pokud si nejste jisti, kontaktujte svého autorizovaného prodejce.

SK POZNÁMKA: Než vrátite krytku na svoje miesto, mal by byť otvor utesnený. Pokiaľ si nieste istý, kontaktujte svojho autorizovaného predajcu.

SLO Pazite! Preden pritrdite pokrovček zatesnite luknjo za vijak, v kolikor ste v dvomih se posvetujte s svojim pooblaščenim servisom.

HR NAPOMENA: Otvor mora biti zabrtvljen prije ponovnog stavljanja poklopca. Ako ste u nedoumici, obratite se ovlaštenoj radionici.

HU Megjegyzés: A nyílásnak tömítve kell lennie, mielőtt a fedetleget visszahelyezik! Ha bizonytalan, kérjük keresse fel helyi képviselőjét.

GR ΣΗΜΕΙΩΣΗ: Η τρύπα θα πρέπει να σφραγιστεί πριν να τοποθετηθεί ξανά το καπάκι. Αν δεν είστε σίγουροι, επικοινωνήστε με το εξουσιοδοτημένο εργαστήριο σας.

TR NOT: Kapak tekrar takılmadan önce deliğe sizdirmaz macun uygulanmalıdır. Emin değilseniz, yetkili servisinizle irtibat kurun.

中文 注意: 外したカバーを再度装着する時はネジ穴をふさいでから装着してください。分かりにくい場合は正規取り付け実施店にご相談下さい。

日本語 注意: 重新安装顶盖之前, 请先将孔口密封。如有疑问, 请咨询经授权的修配厂。



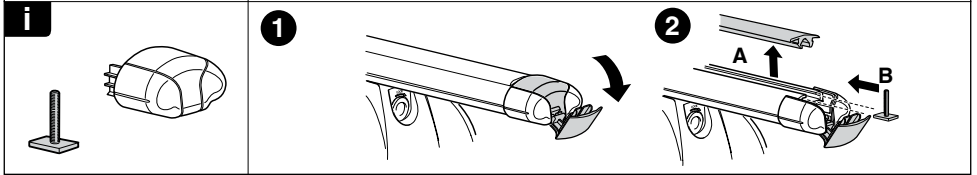
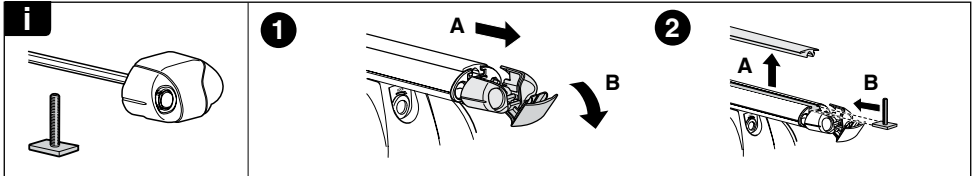
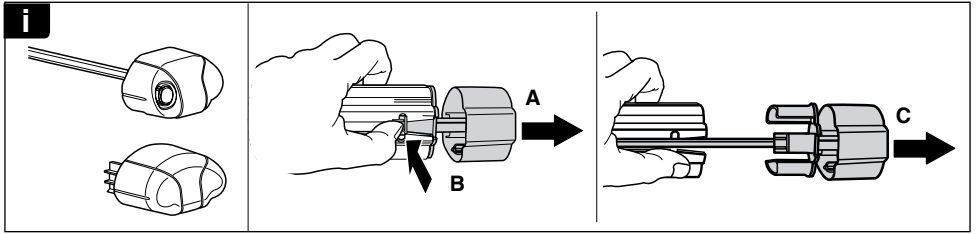

한국어 참고: 커버를 다시 장착하기 전에 반드시 구멍을 막아야 합니다. 잘 모르시는 경우에는 가까운 공인 서비스센터에 문의하시기 바랍니다.

ไทย หมายเหตุ: ควรอุดรูนี้ก่อนสวมฝาครอบกลับคืน หากคุณไม่แน่ใจ โปรดติดต่อร้านติดตั้งที่ได้รับอนุญาต

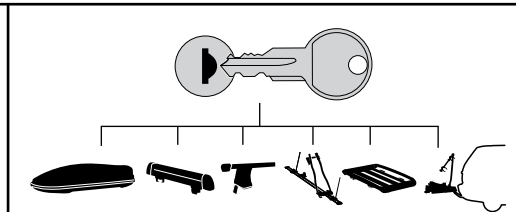

THULE
SWEDEN
**ONE
KEY
SYSTEM**



-  544 (x4)
-  596 (x6)
-  588 (x8)
-  NA 510 (x10)
-  EUR 452 (x12)

WW ▶ Thule Sweden AB, Box 69, 330 33 Hillerstorp, SWEDEN
NA ▶ Thule Inc., 42 Silvermine Road, Seymour, Connecticut 06483, USA

info@thule.com
customer.service@thule.com

 www.thule.com

506-3015-02