

# Kit 3069

- FORD Mondeo (Mk.II.), 4-dr Sedan, 01-07
- FORD Mondeo (Mk.II.), 5-dr Hatchback, 01-07
- MAZDA Atenza (Mk.I.), 4-dr Sedan, 02-07
- MAZDA Atenza (Mk.I.), 5-dr Hatchback, 02-07
- MAZDA Atenza (Mk.II.), 4-dr Sedan, 08–
- MAZDA Atenza (Mk.II.), 5-dr Hatchback, 08–
- MAZDA Axela, 4-dr Sedan, 04-08
- MAZDA Axela, 5-dr Hatchback, 04-08, 09–
- MAZDA CX-7, 5-dr SUV, 07–
- MAZDA CX-9, 5-dr SUV, 07–
- MAZDA Demio, 5-dr Hatchback, 07–
- MAZDA 2, 5-dr Hatchback 07–
- MAZDA 3, 4-dr Sedan, 04-08 / \*04-09, 10–
- MAZDA 3, 5-dr Hatchback, 04-08, 09– / \*04-09, 10–
- MAZDA 6 (Mk.I.), 4-dr Sedan, 02-07 / \*03-08
- MAZDA 6 (Mk.I.), 5-dr Hatchback, 02-07 / \*02-04, 05-07
- MAZDA 6 (Mk.II.), 4-dr Sedan, 08–
- MAZDA 6 (Mk.II.), 5-dr Hatchback, 08–

\*North America

This Kit is only for vehicles with fixpoint mounting.

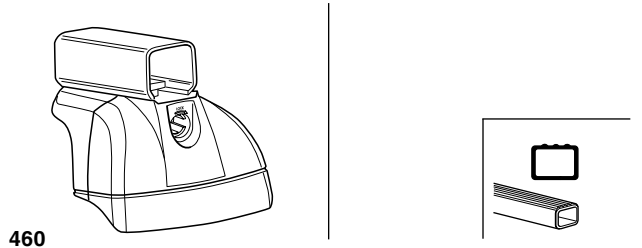
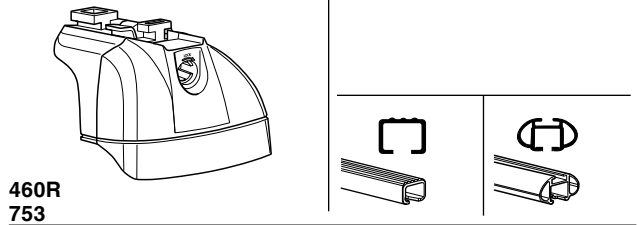

xx kg  
 xx lbs + 5 kg  
 11 lbs = **Max. 75kg**  
**Max. 165 lbs**

80 km/h 130 km/h  
 50 Mph 80 Mph  
 40 km/h 25 Mph  
**km/h**  
**Mph**

+ Kit XXXX

**A** **B** **C**

**04** x 4  
**03** x 2  
**04** x 2  
 x 1

**50962**

27 mm x 4  
 x 4  
 x 4  
 x 4  
 x 1  
 3 mm  
 x 1

**Kit**



753

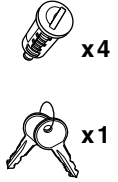
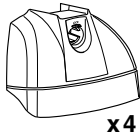

460R

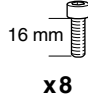
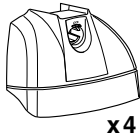
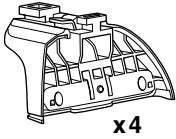

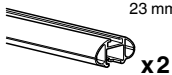
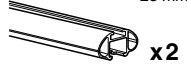
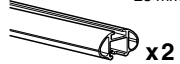
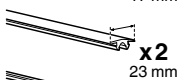
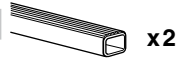
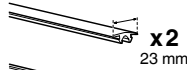
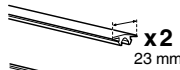
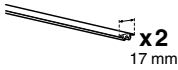
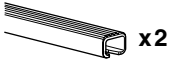
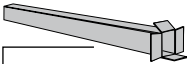
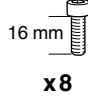
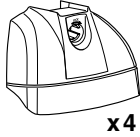
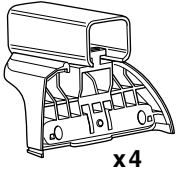

460

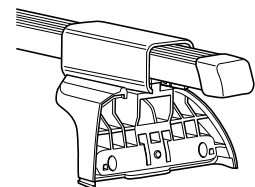
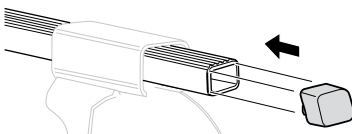
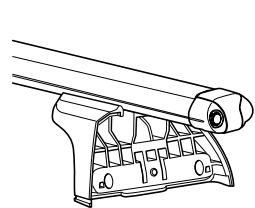
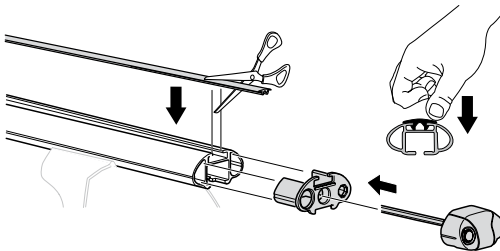
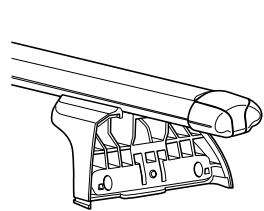
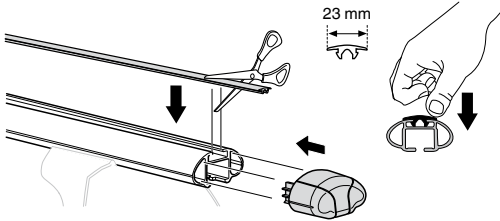
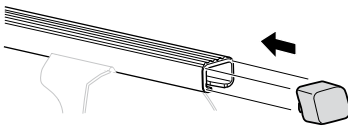
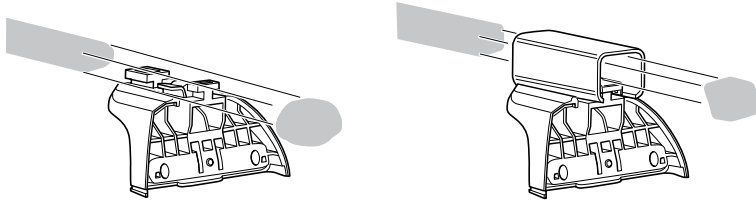
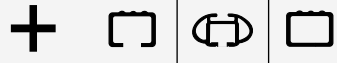

1

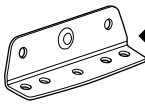
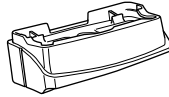

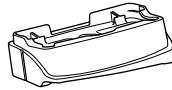
**2**◀ **04** x 4◀ **03** x 216 mm  x 8◀ **04** x 2

x 1

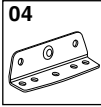
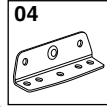
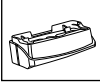
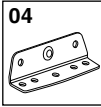
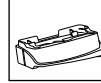
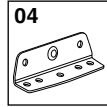
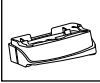
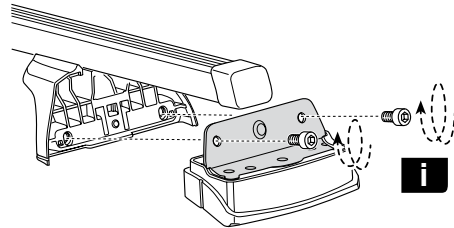
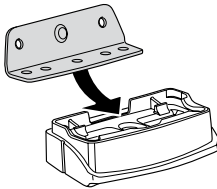
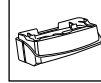
**03****04****04****03****i**

**GB** Only a few turns  
**D** Nur wenige Umdrehungen  
**F** Quelques tours uniquement  
**NL** Slechts enkele slagen  
**I** Solo qualche giro  
**E** Sólo algunas vueltas  
**PT** Noções básicas  
**S** Endast några varv  
**FIN** Vain muutama kierros

**EST** Ainult mõni pööre  
**LAT** Tikai dažī apgriezieni  
**LIT** Tik keli pasukimai  
**PL** Wystarczy kilka obrotów  
**RU** Достаточно нескольких оборотов  
**CZ** Pouze několik otáček  
**SK** Len niekoľko otáčok  
**SLO** Le nekaj obratov

**HR** Samo nekoliko okreta  
**HU** Csak néhány fordítás  
**GR** Μόνο μερικές στροφές  
**TR** Yalnız birkaç kez çevirm  
**中文** 只有几个转向  
**한국어** 두 세번만  
**日本語** 数回転のみ  
**ไทย** หมุนเพียงไม่กี่รอบ

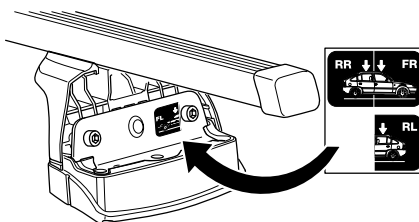

**3**

x 4



x 4



x 4



x 4

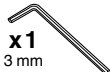

x 1

3 mm

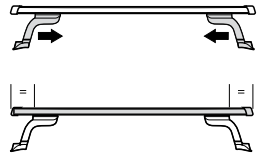
**A**

FORD

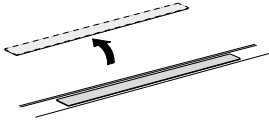

MAZDA

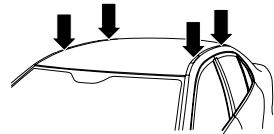
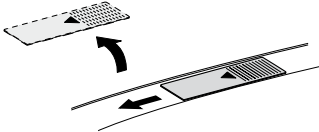
**B**

FORD

2 Nm

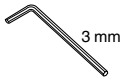

3 mm

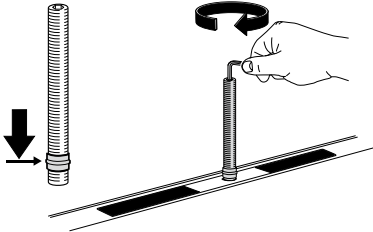

MAZDA

2 Nm

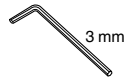

3 mm

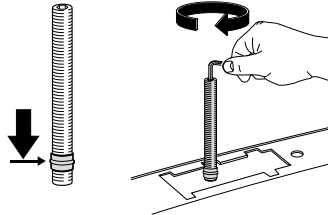
**C**

FORD

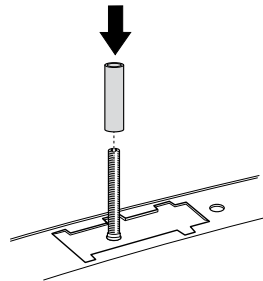

MAZDA

**D**

FORD

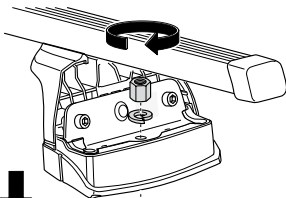

MAZDA

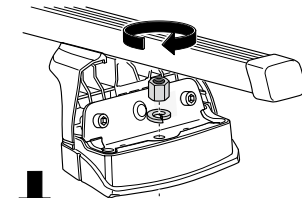

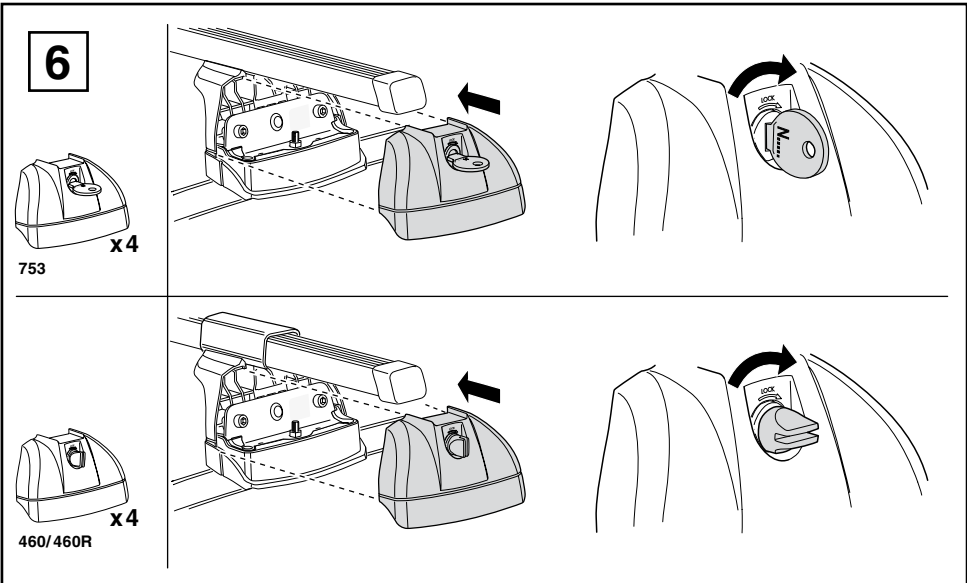
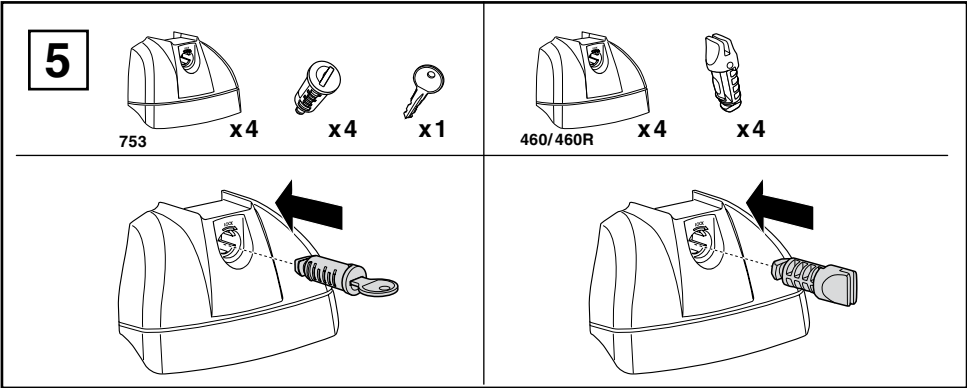
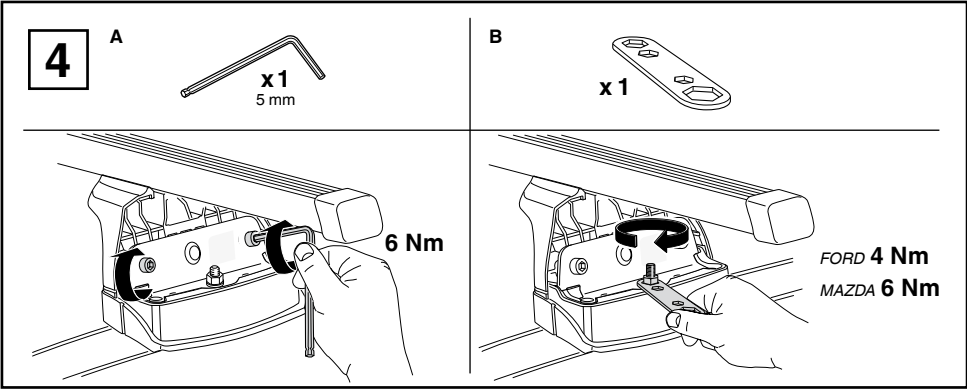

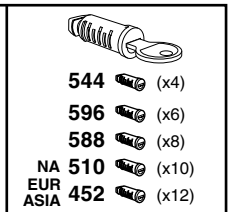

**WW** ▶ Thule Sweden AB, Box 69, 330 33 Hillerstorp, SWEDEN

**NA** ▶ Thule Inc., 42 Silvermine Road, Seymour, Connecticut 06483, USA

**@** info@thule.com  
customer.service@thule.com

**www.thule.com**