

# Kit 3083

**MERCEDES C-Class (W204), 4-dr Sedan, 07–**  
**MERCEDES E-Class (C207), 2-dr Coupè, 09–**  
**MERCEDES E-Class (W212), 4-dr Sedan, 09–**

This Kit is only for vehicles with fixpoint mounting and glassroof.

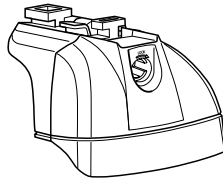

**460R  
753**

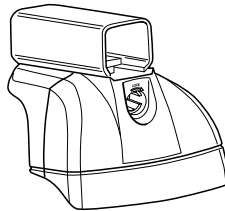
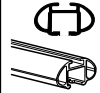

**460**

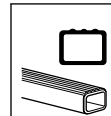

**Kit**

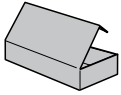

753

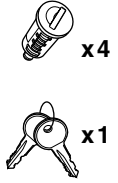
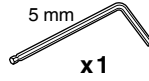
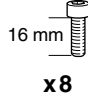
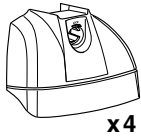
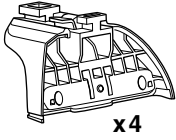

460R

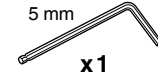
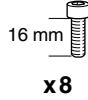
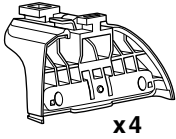

460

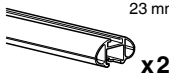
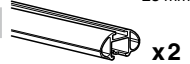
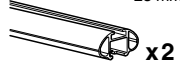
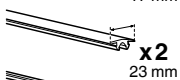
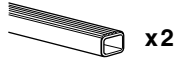
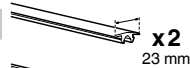
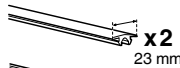
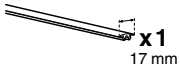
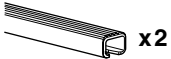
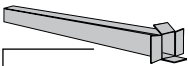
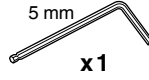
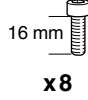
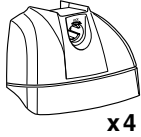
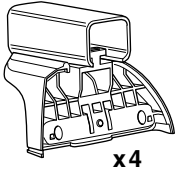

1

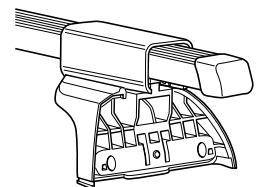
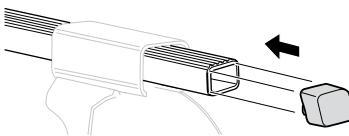
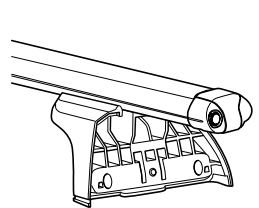
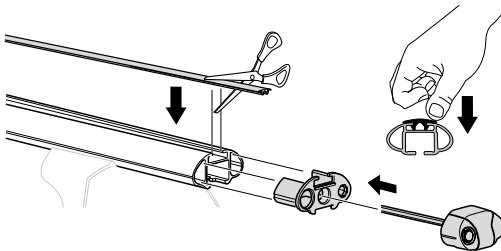
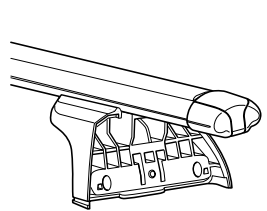
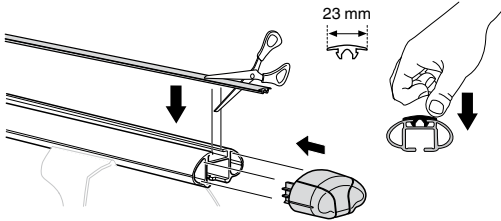
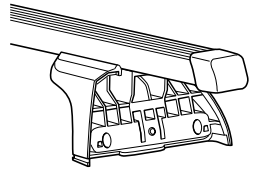
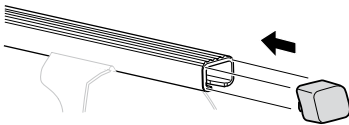
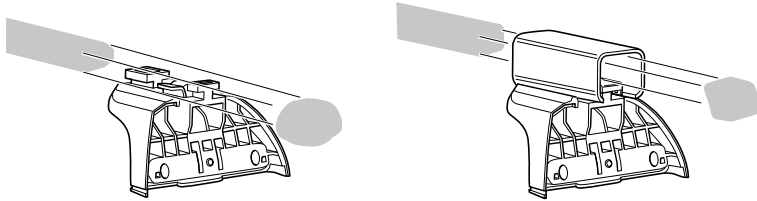
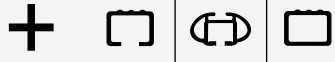
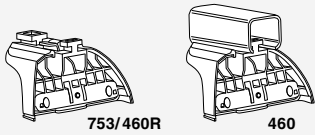

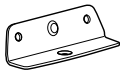
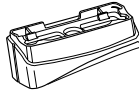
**2****20** x 4**126** x 1

16 mm x 8

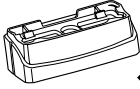
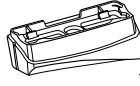
**125** x 2**127** x 1

x 1

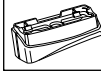
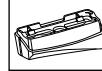
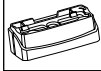
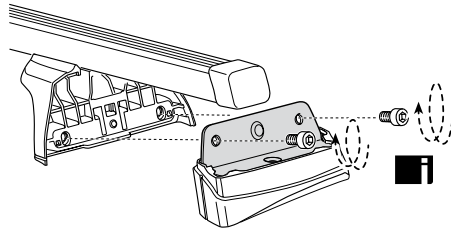
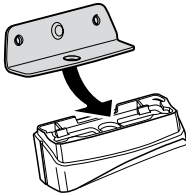
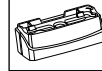
**20****126****20****127****20****125****20****125****i**

**GB** Only a few turns  
**D** Nur wenige Umdrehungen  
**F** Quelques tours uniquement  
**NL** Slechts enkele slagen  
**I** Solo qualche giro  
**E** Sólo algunas vueltas  
**PT** Noções básicas  
**S** Endast några varv  
**FIN** Vain muutama kierros

**EST** Ainult mõni pööre  
**LAT** Tikai dažī apgriezieni  
**LIT** Tik keli pasukimai  
**PL** Wystarczy kilka obrotów  
**RU** Достаточно нескольких оборотов  
**CZ** Pouze několik otáček  
**SK** Len niekoľko otáčok  
**SLO** Le nekaj obratov

**HR** Samo nekoliko okreta  
**HU** Csak néhány fordítás  
**GR** Μόνο μερικές στροφές  
**TR** Yalnız birkaç kez çevirm  
**中文** 只有几个转向  
**한국어** 두 세번만  
**日本語** 数回転のみ  
**ไทย** หมุนเพียงไม่กี่รอบ

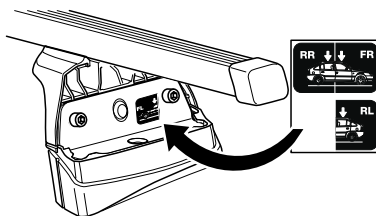

**3**



x4



x4



x4

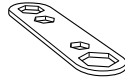

x1

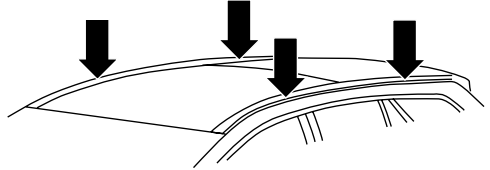

**A**

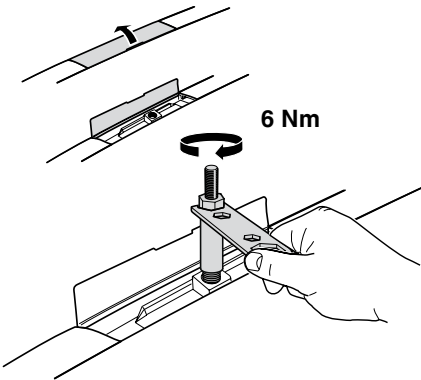

**B**

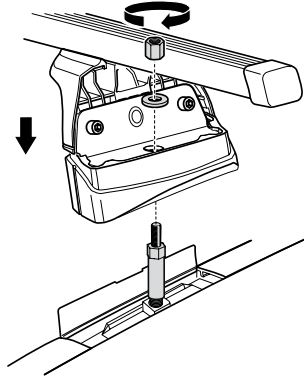

**C**

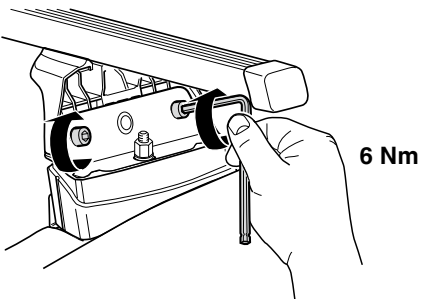

**D**

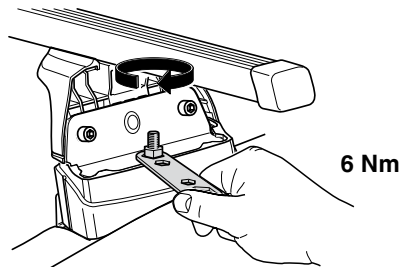

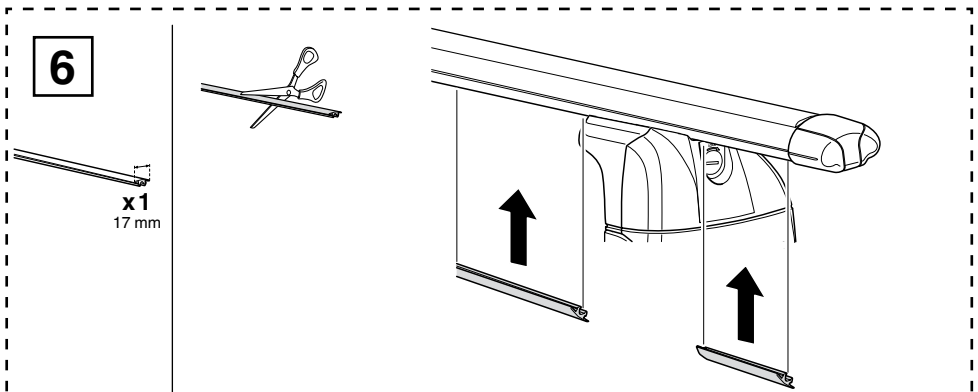
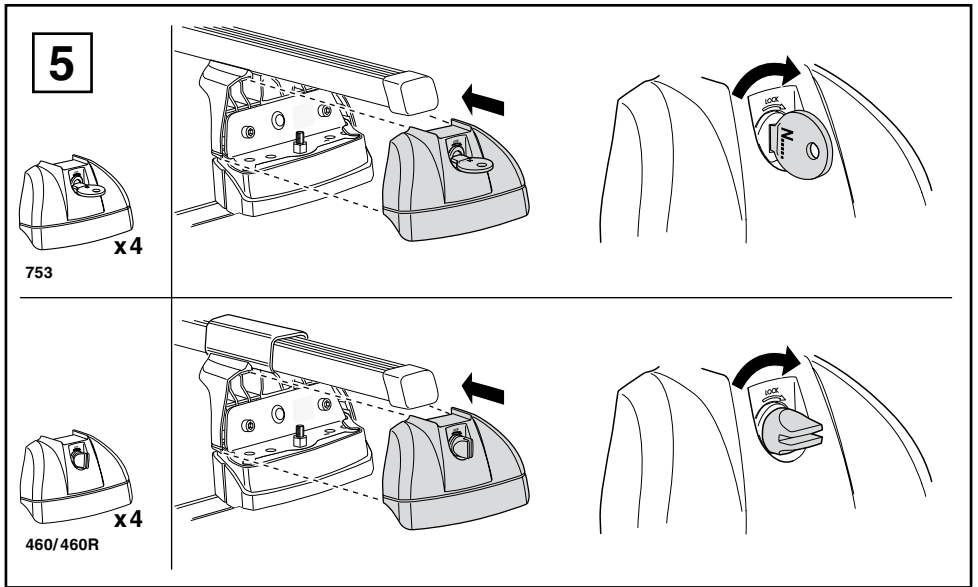
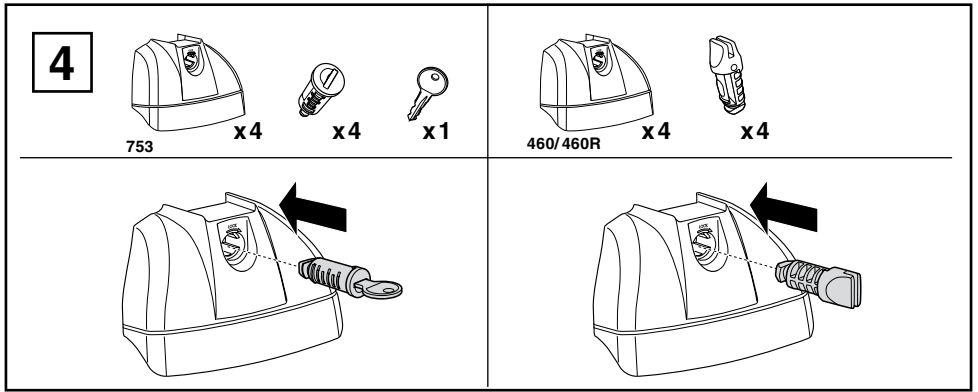

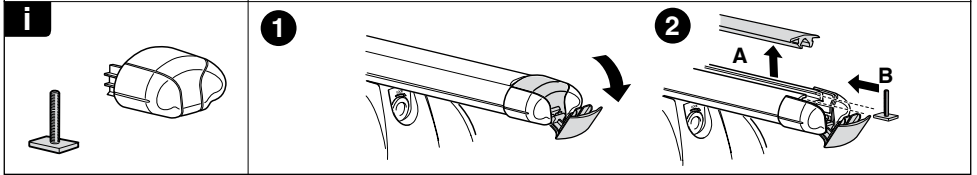
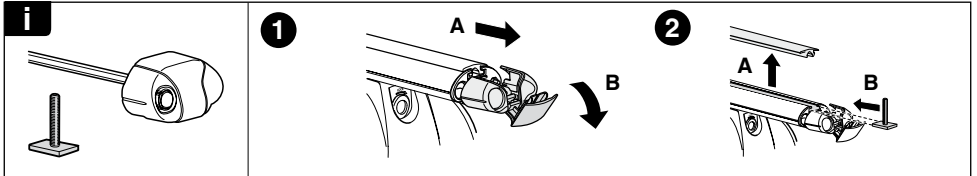
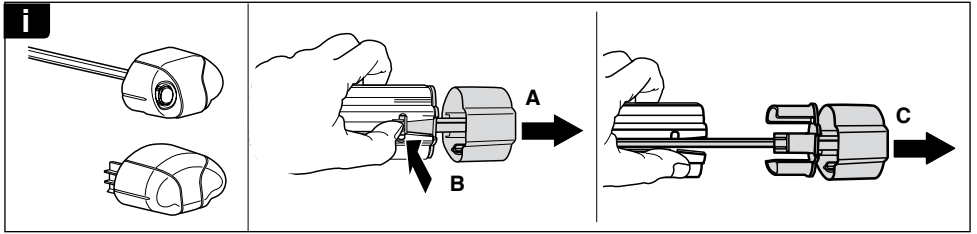



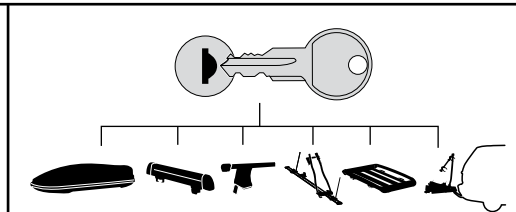

**THULE**  
SWEDEN  
**ONE  
KEY  
SYSTEM**



-  **544** (x4)
-  **596** (x6)
-  **588** (x8)
-  **NA 510** (x10)
-  **EUR 452** (x12)

**WW** ▶ Thule Sweden AB, Box 69, 330 33 Hillerstorp, SWEDEN  
**NA** ▶ Thule Inc., 42 Silvermine Road, Seymour, Connecticut 06483, USA

 [info@thule.com](mailto:info@thule.com)  
[customer.service@thule.com](mailto:customer.service@thule.com)

 [www.thule.com](http://www.thule.com)

506-3083-02