



Thule XT Kit 3144

> Instructions

MITSUBISHI L200, 4-dr Double Cab, 15-

MITSUBISHI Triton, 4-dr Double Cab, 15-

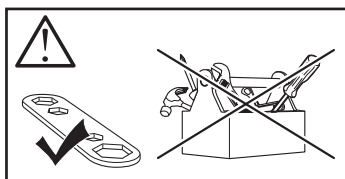

This kit is only for vehicles with fixpoint mounting.

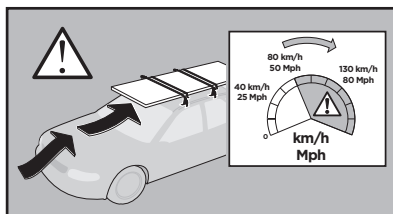
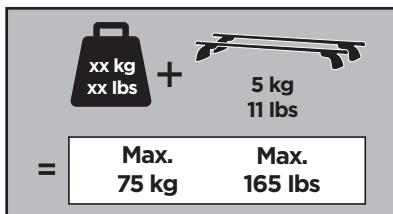
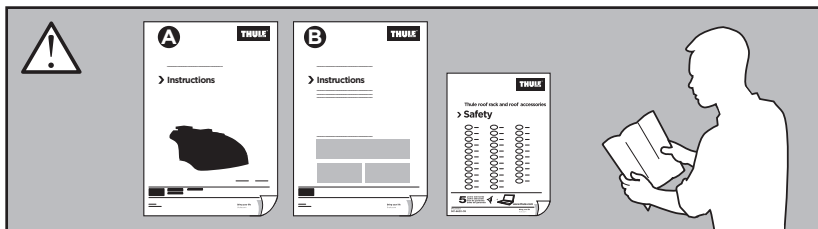

ISO 11154-E

183144

C.20160113
509-3144-01

Bring your life
thule.com

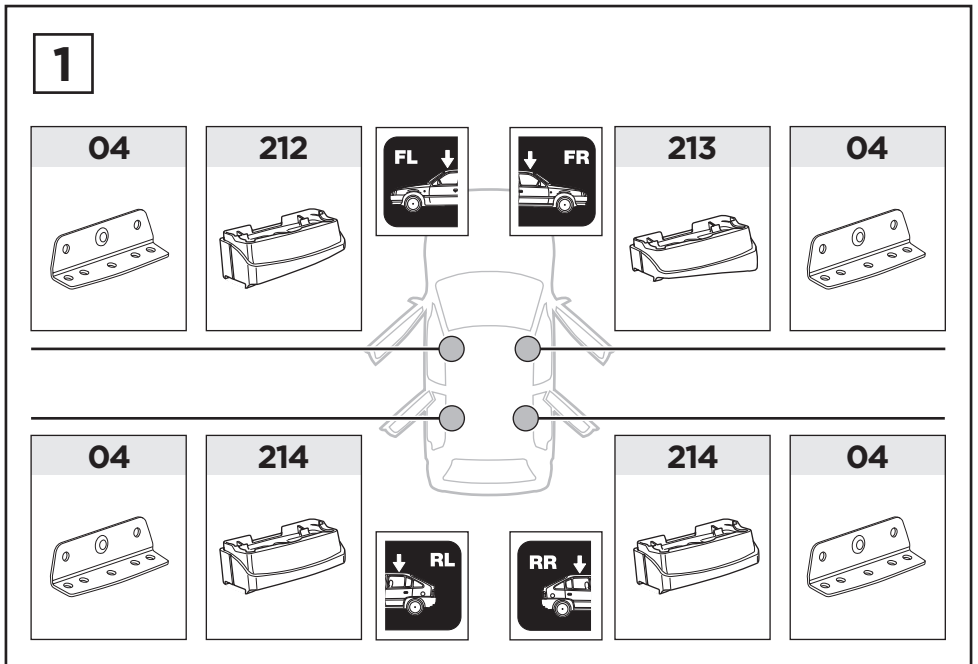
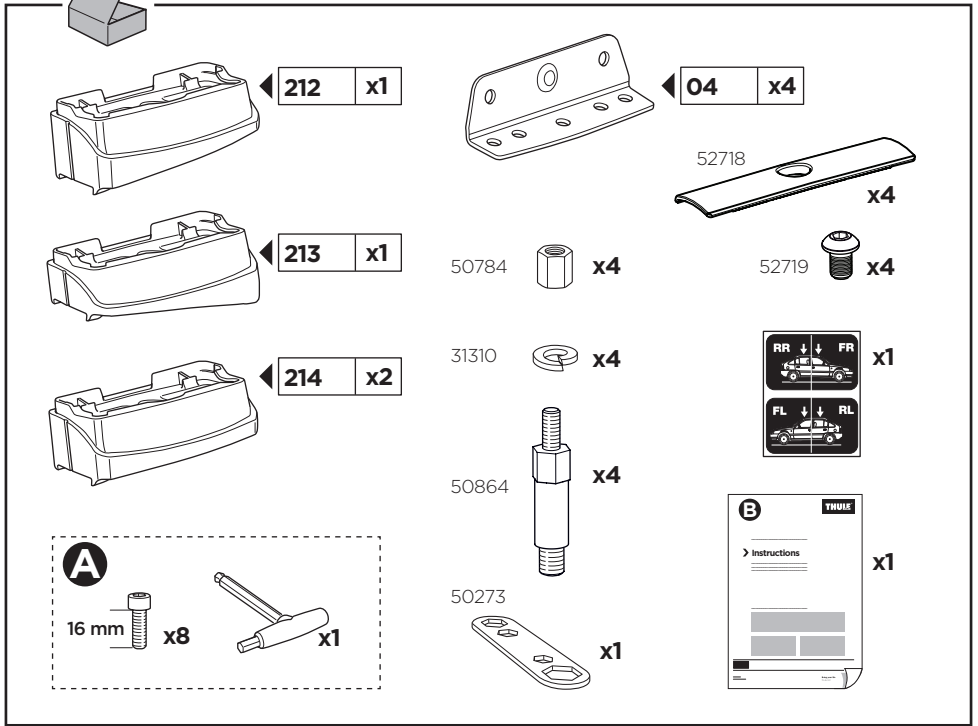

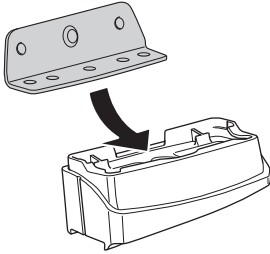
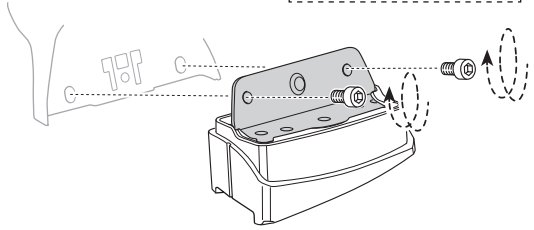
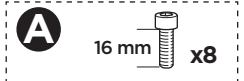
2**A****B**

EN Only a few turns
DE Nur wenige Umdrehungen
FR Quelques tours uniquement
NL Slechts enkele slagen
IT Solo qualche giro
ES Sólo algunas vueltas
PT Apenas algumas voltas
SV Endast några varv
DK Kun nogle få omgange
NO Bare noen få omdreininger
FI Vain muutama kierros

ET Ainult mõni pööre
LV Tikai daži apgriezieni
LT Tik keli pasukimai
PL Wystarczy kilka obrotów
RU Только несколько оборотов
UK Лише декілька обертів
BG Само няколко завъртания
CS Pouze několik otáček
SK Len niekoľko otáčok
SL Le nekaj obratov
HR/BIH Samo nekoliko okreta

RO Doar câteva rotiri
HU Csak néhány fordítás
EL Μόνο λίγες περιστροφές
TR Yalnızca birkaç tur

بعض دورات فقط **AR**

רק מספר סיבובים **HE**

ZH 仅几圈

JA 2～3回転のみ

KO 몇 번만 돌리면 됨

TH เพียงสองสามรอบ

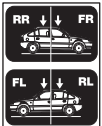
3

x1

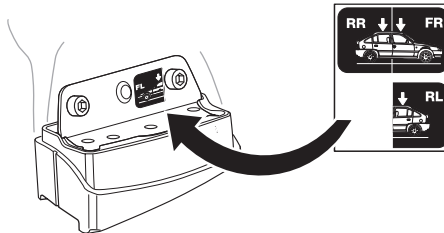

4

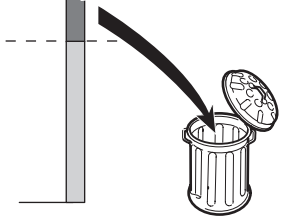
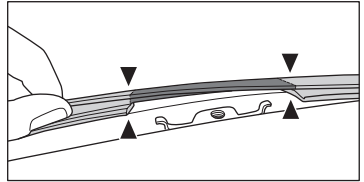
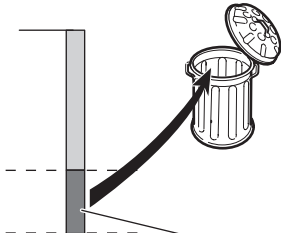
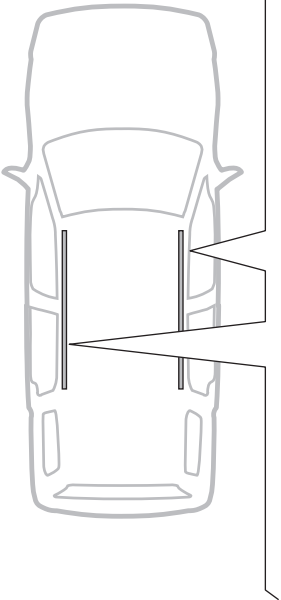
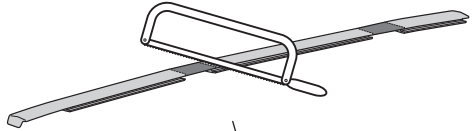
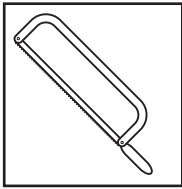
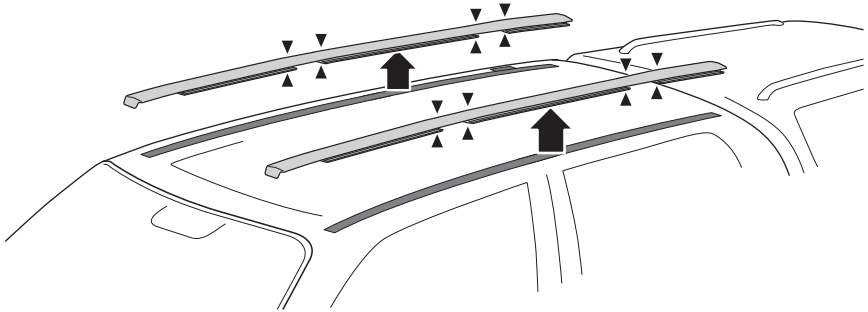

5

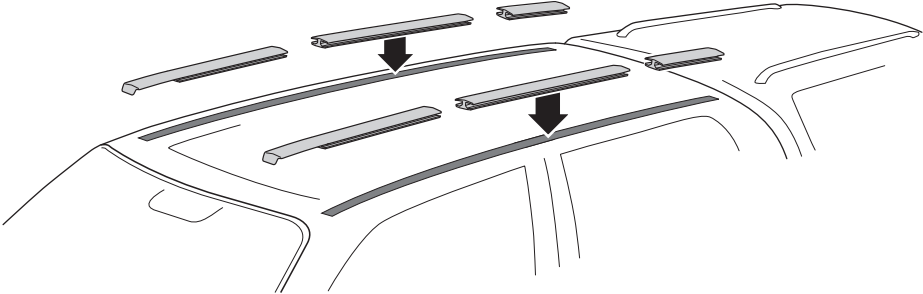

6

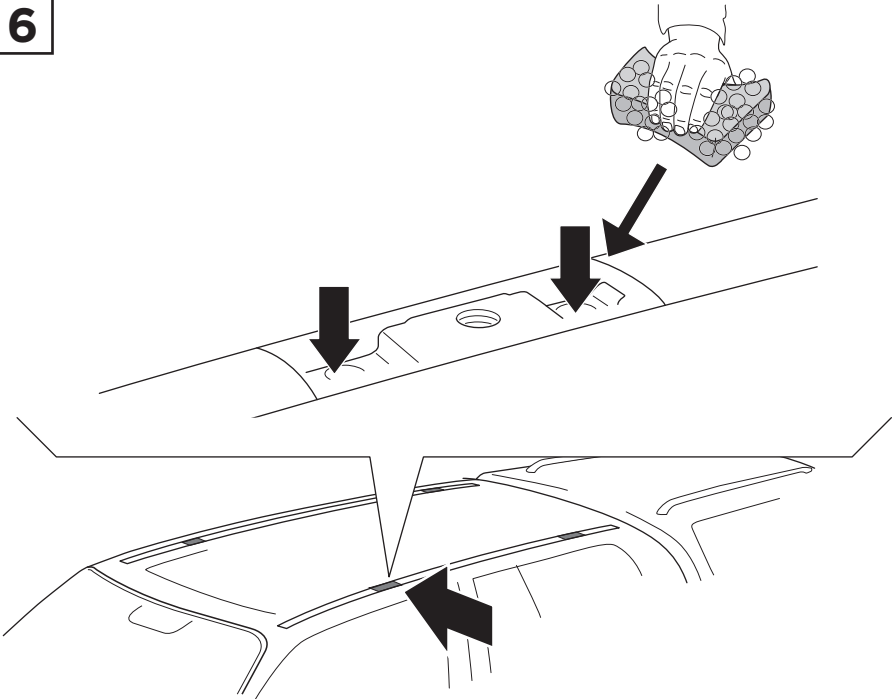

7

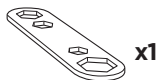

A

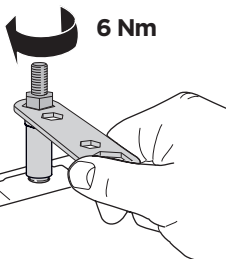
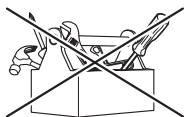
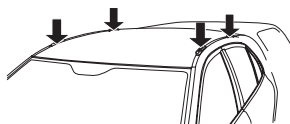

B

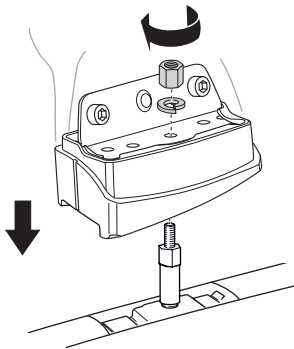

8

A

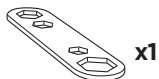
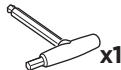

A

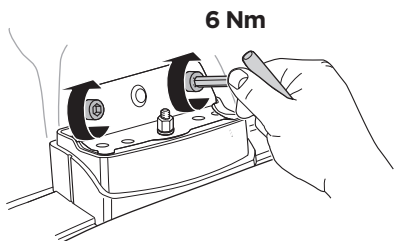

B

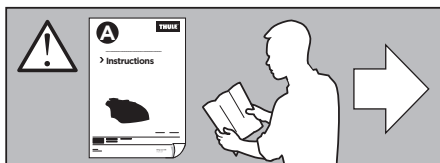
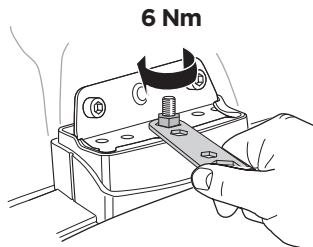

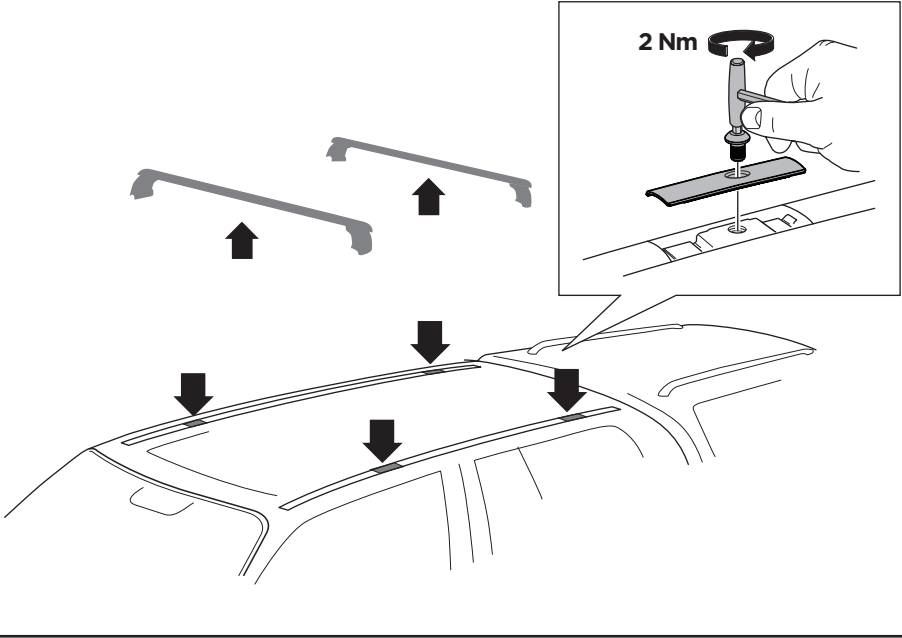
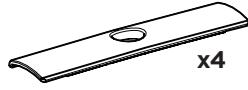
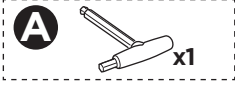



Thule Sweden AB, Box 69, 330 33 Hillerstorp, SWEDEN
Thule Inc., 42 Silvermine Road, Seymour, Connecticut 06483, USA



info@thule.com
Phone: 800-238-2388



www.thule.com